

ENVISIONING DEVELOPMENT / Guide No. 2

WHAT IS ZONING?

NEW YORK CITY EDITION



Copyright ©2013
The Center for Urban Pedagogy
All rights reserved

Published by
The Center for Urban Pedagogy
232 Third Street #D201
Brooklyn, NY 11215
info@welcometoCUP.org

“What is Zoning?”
is a guidebook from the Envisioning
Development Toolkit Program

Written and edited by
Christine Gaspar, Mark Torrey,
and John Mangin

Developed by
John Mangin, Rosten Woo,
Christine Gaspar, and Mark Torrey

Designed by
Jeff Lai and Andrew Sloat

The Center for Urban Pedagogy
(CUP) is a nonprofit organization
that uses the power of design and
art to increase meaningful civic
engagement, particularly among
historically underrepresented
communities.

CUP collaborates with designers,
educators, students, and
communities to make educational
tools that demystify complex policy
and planning issues.

We believe that increasing
understanding of how these
systems work is the first step to
better, more equitable, and more
diverse community participation.

welcometoCUP.org

Envisioning Development is a set
of portable, interactive, workshop
tools designed to help experts
and laypeople communicate. Each
tool translates abstract concepts
and language into straightforward
activities and physical objects
that let people learn by looking,
doing, and listening to each other.

CUP works with an advisory
board of community organizations
and land use and planning
experts to determine which
topics they most need assistance
explaining to their communities.
CUP researches the concepts
and works in consultation with
community partners to break the
information down into visual,
hands-on, interactive teaching
tools. The tools are tested
extensively by our community
partners. They are distributed
citywide to housing and planning
organizations, who use the
tools in their own advocacy and
organizing work.

Other tools in the series include:

- What is Affordable Housing?—
NYC Edition
- What is Affordable Housing?—
Chicago Edition

Contents

HOW ZONING WORKS

- 6 What is zoning?
- 10 What is zoning for?
- 22 How does zoning affect land use?
- 42 How does zoning affect the size and shape of buildings?
 - 78 What is a rezoning?
 - 90 How can zoning make my neighborhood better?

THE WORKSHOP

- 108 Using the Zoning Toolkit
 - 110 What’s in the box?
 - 112 Why zoning?
 - 116 What is “use zoning”?
 - 124 How does a mixed use rezoning work?
 - 126 How does size & shape zoning work?
- 136 How does a size & shape rezoning work?
 - 140 What is inclusionary zoning?
 - 144 What’s my zone?

Acknowledgements

This book benefited greatly from the guidance and advice of the following individuals and organizations:

Vicki Been, Furman Center for Real Estate & Urban Policy
Michelle De La Uz, Fifth Avenue Committee
Mark Foggin, Public Works Partners
Anne Frederick, Hester Street Collaborative
Michael Freedman-Schnapp, Council Member Brad Lander's Office
Michael Heimbinder, HabitatMap
Matt Klein, Housing Conservation Coordinators
Jeff Lai, Designer
Brad Lander, New York City Council Member
Juan Camilo Osorio, Pratt Institute
Paul Parkhill, Spaceworks
Frank Ruchala Jr., Department of City Planning
Lucas Shapiro, FUREE
Andrew Sloat, Designer
Lacey Tauber, Pratt Institute

And all of the community residents, students, and friends who helped us test and revise the book and activities:

Tom Angotti, Hunter College
Eve Baron, Municipal Art Society Planning Center
Bettina Damiani, Good Jobs New York
Benjamin Dulchin, ANHD
Richard Lee, AAFE
Bethany Li, AALDEF
David Powell
Damaris Reyes, GOLES
Lisa J. Servon, The New School for Public Engagement
Susanna Schaller, City College of New York
Elana Shneyer, Pratt Area Community Council
Ericka Stallings, ANHD
Vicki Weiner, Pratt Center
Rosten Woo

This project is indebted to the work of Andrew Watanabe, Laura Wolf-Powers, and the Furman Center for Real Estate & Urban Policy.

Special thanks to:

Clara Amenyó, **Tess Bath**, **Pema Domingo-Barker**, **Sam Holleran**,
Jeff Kasper, **Lize Mogel**, **Valeria Mogilevich**, **Oscar Nunez**,
Sarah Serpas, **Matt Zebrowski**

Support for this project was provided by The Nathan Cummings Foundation; the Surdna Foundation; public funds from the New York City Department of Cultural Affairs in partnership with the City Council and the National Endowment for the Arts; and Sappi Ideas that Matter.

CUP's programs are supported in part by: The Lily Auchincloss Foundation; the Scherman Foundation; the Union Square Awards, a project of the Tides Center; the David Rockefeller Fund; and North Star Fund.



Photos on pages 22, 23, 24, 25, 28, 29, 32, 33 are in the public domain.

Photo, page 40: 23rd Street, east from 6th Ave., New York, N.Y. Print & Photographs Online Catalog (PPOC). Collection: Detroit Publishing Company. In Library of Congress. Retrieved October 22, 2013, from <http://www.loc.gov/pictures/item/det1994020586/PP/>.

Photo, page 76: UCLA Department of Geography, Benjamin and Gladys Thomas Air Photo Archives, Fairchild Aerial Surveys Collection

All other photos: Copyright © 2013 The Center for Urban Pedagogy, all rights reserved.

Middle photo, page 33: thanks to Lite Brite Neon Studio & Esther Ruiz

Cover printed on Sappi Flo Gloss paper.

What is zoning?

Most cities have rules about what you can build where. These rules make up zoning law.

This guide will help you understand what zoning is, and how it works in New York City.



Say you own
a piece of land.

*What would you
build on it?*



A HOUSE WITH A YARD?



A DEPARTMENT STORE?

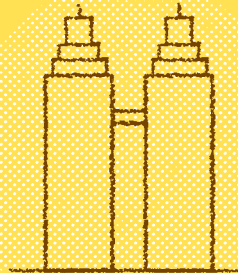

A HIGH-RISE?

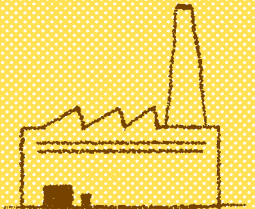

A FACTORY?



What you can build depends on where—or in what ‘zone’—your property is.

The city uses zoning to group land into different areas, or zones, with different rules about what you can build in each one.

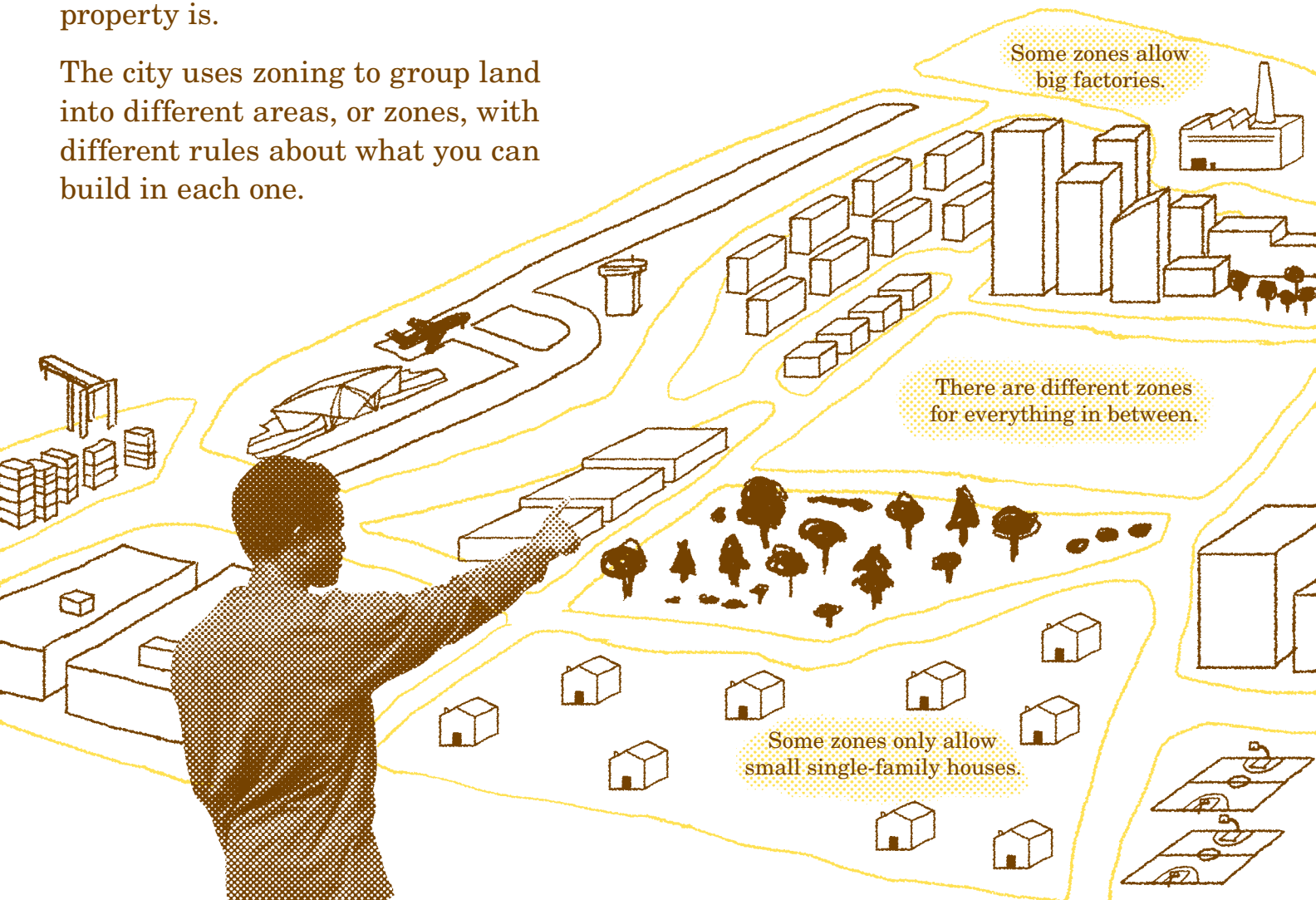

What is zoning for?

Zoning keeps similar things together and keeps apart things that don't go well together.

There are two big ways that zoning groups similar things—by the types of activities that happen in them, and by their size and shape.

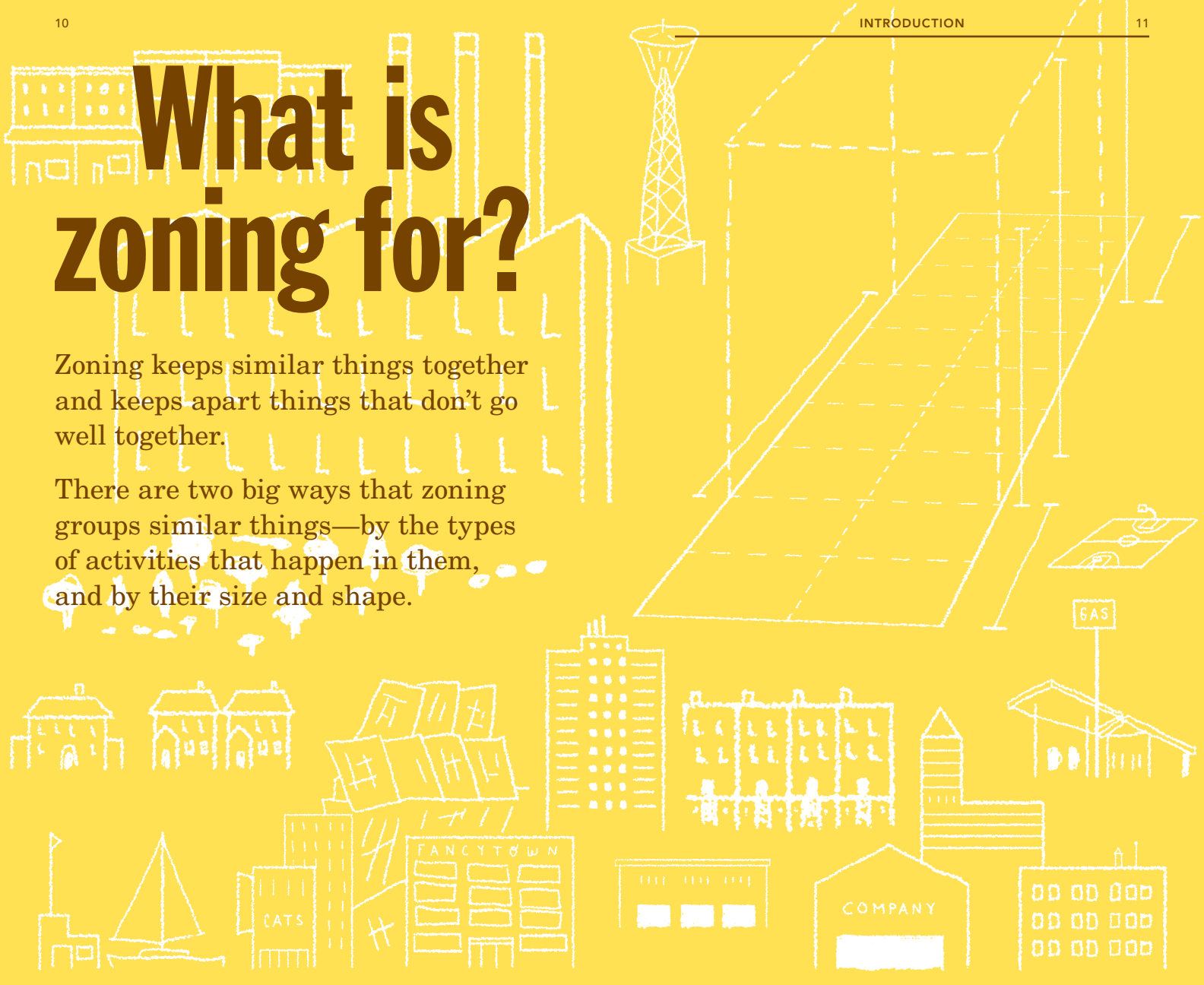

The part of zoning that separates different building uses is called “use zoning” or “land-use zoning.”

Let's say you build a house on your lot.

NICE!

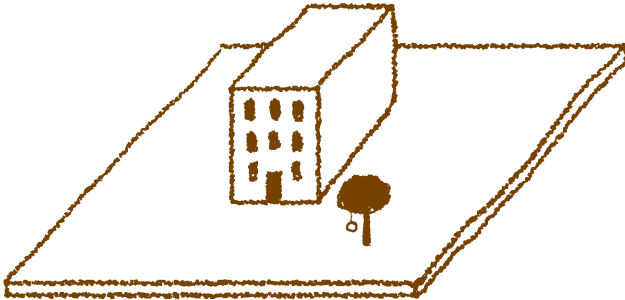

Zoning law keeps housing in one zone, and factories in another.

... then someone builds a jackhammer factory next door.

NOT SO NICE!

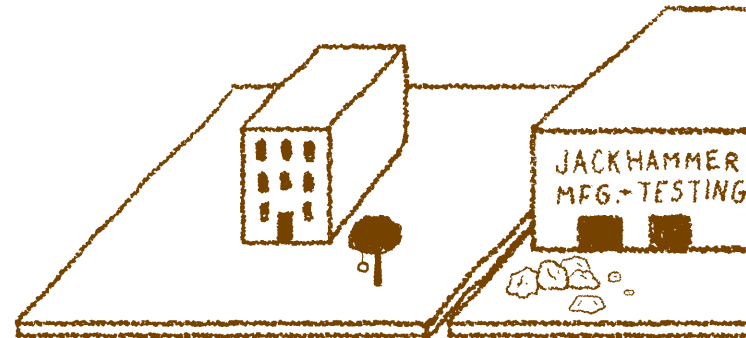

The other part of zoning law controls the size and shape of buildings in each zone.

Planning the size and shape of buildings can prevent overcrowding, protect public health and safety, and make neighborhoods nicer places to live.

Zoning doesn't actually build anything. It just guides and limits what people can build in different zones.

Back to your nice house.

NICE!

Let's say a developer builds a high-rise next door.

NOT SO NICE!

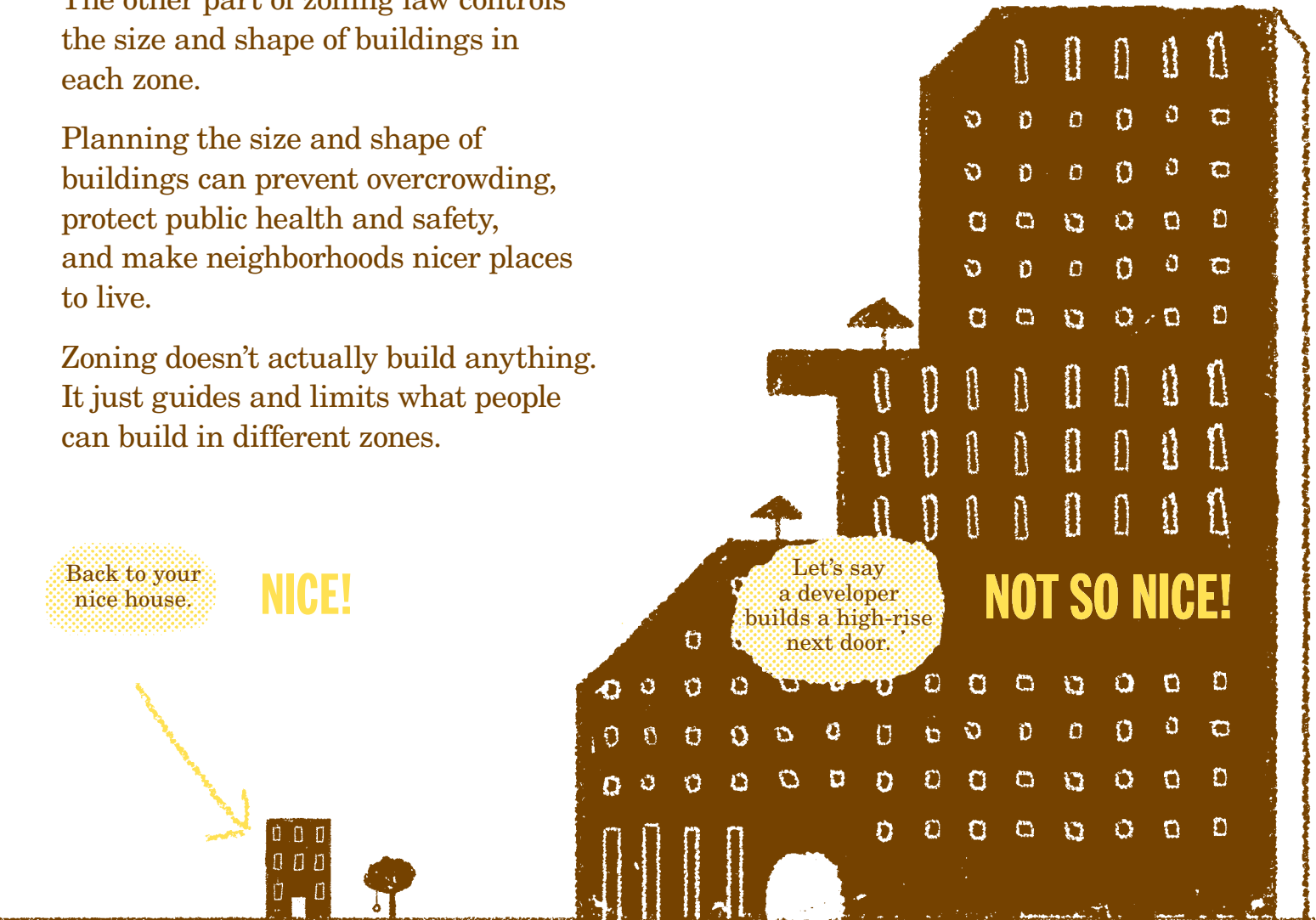

Zoning works at different scales—the building scale, the neighborhood scale, and the city scale.

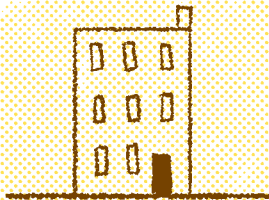

BUILDING

What can I build on my lot?

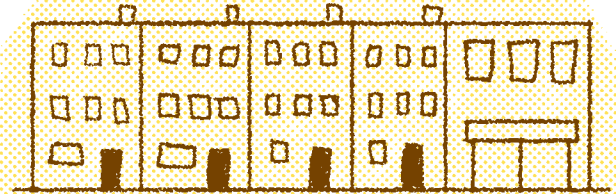

NEIGHBORHOOD

What do the buildings look like and how do they relate to each other? Where do people live and where do they shop? What parts of the neighborhood are quiet and what parts are busy?

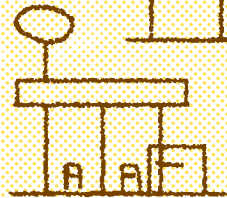
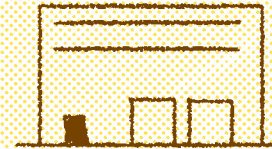
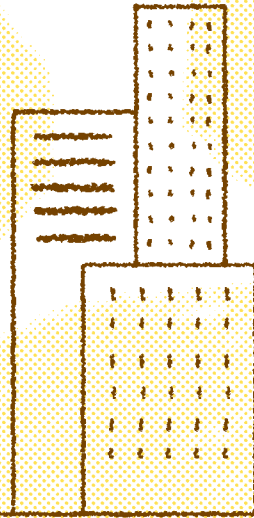

CITY

Where are the industrial zones? Where are the regional commercial centers? What parts of the city need to be protected from further development?

If you own a property in a single family housing zone, you can't build a luxury high-rise.

But neither can your neighbors.

So that means everyone in the neighborhood knows they are playing by the same rules.

Ideally, zoning balances private property rights with the interests of the public. That's important in a city where lots of people live really close to each other.

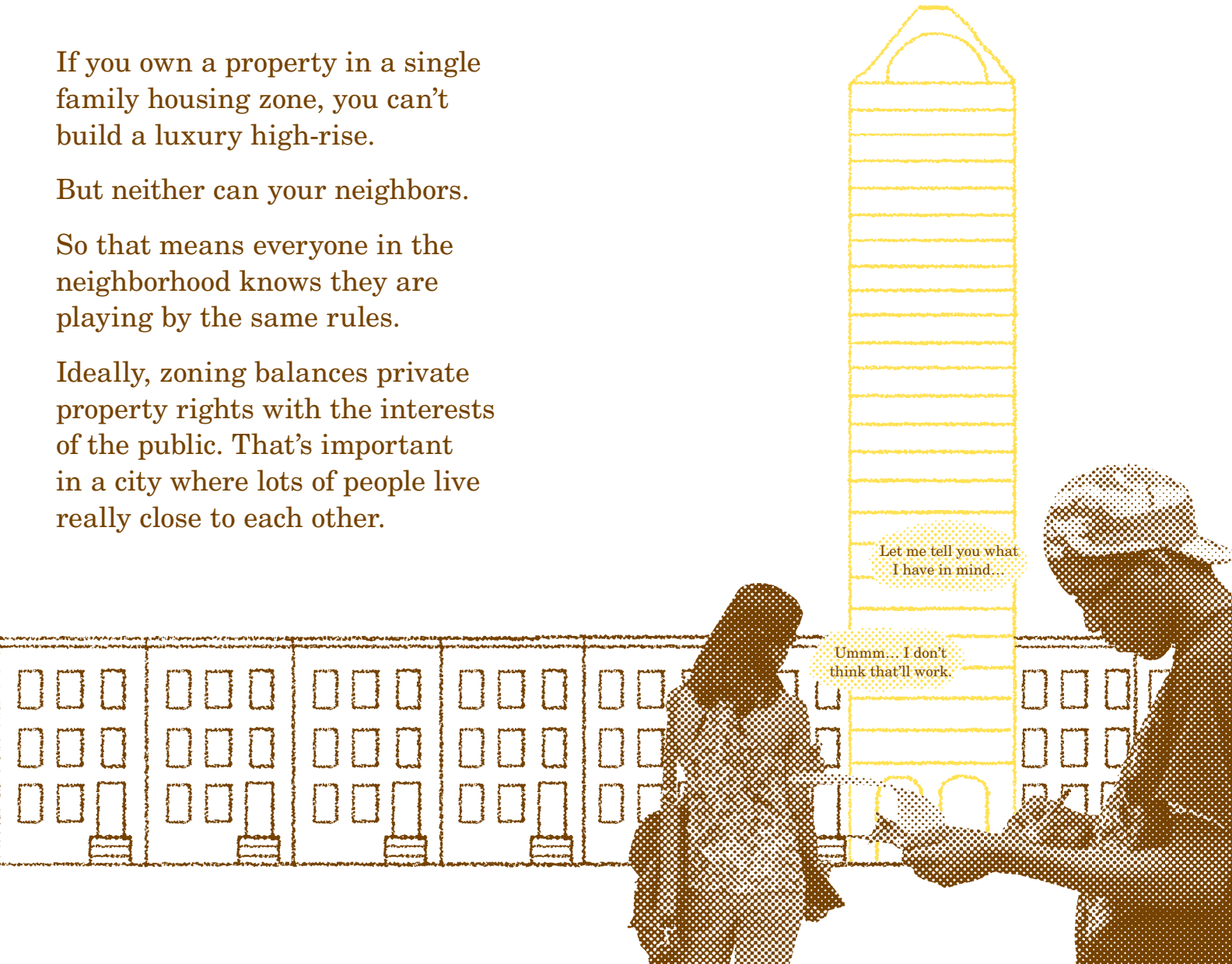

Because people have different ideas about how a building or a block should look, or how a neighborhood or the city should grow and change, people fight about zoning.

It can be really controversial.

Let's take a closer look at how zoning works and at what it does and doesn't do.

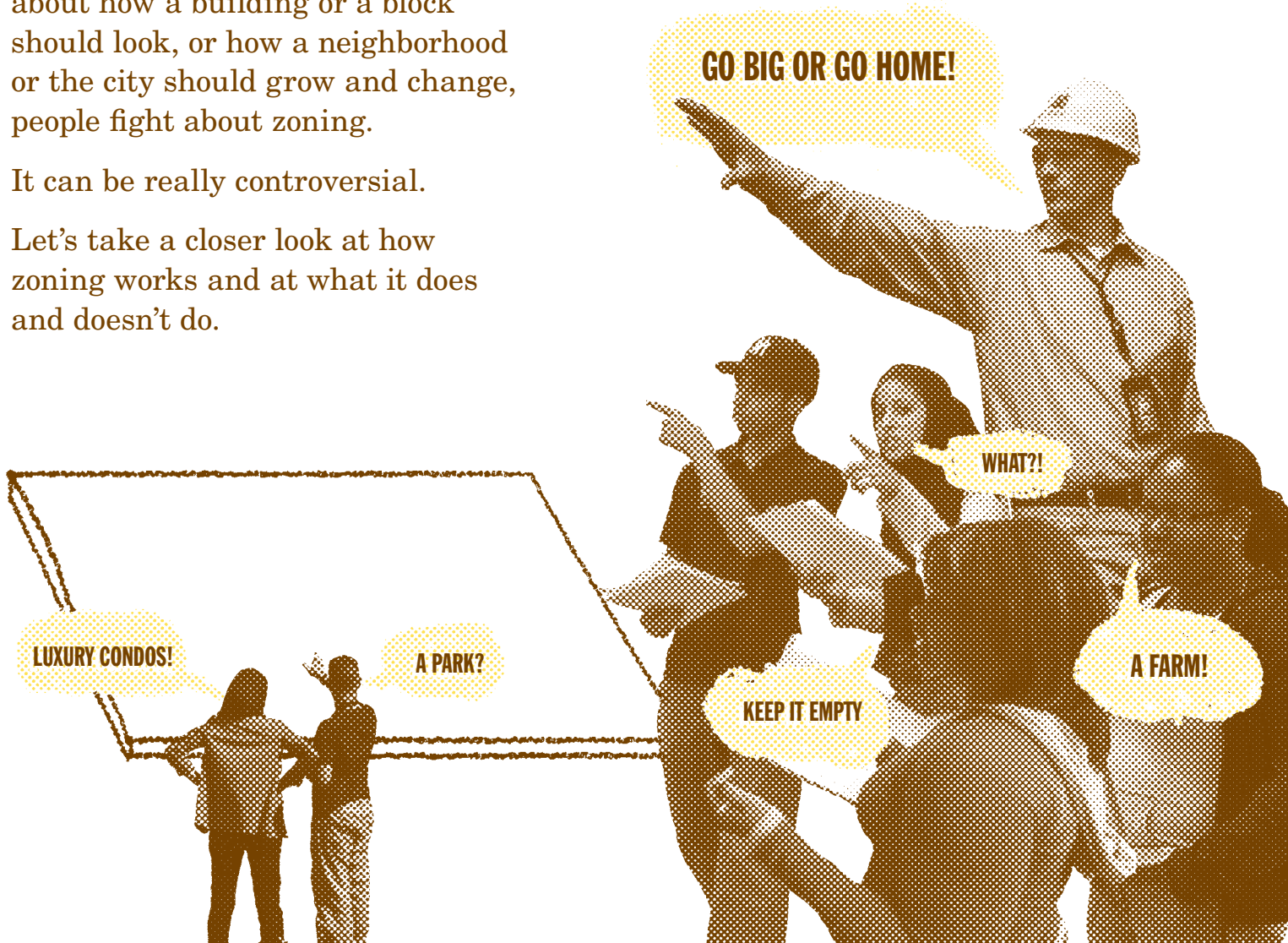

How does zoning affect land use?

“Use zoning” guides which types of building uses can go in different areas. New York City has four land use categories:

Residential

Commercial

Manufacturing

Special Purpose

There are 10 kinds of residential zones in the city, from single-family detached houses (R1) to high-density towers (R10).

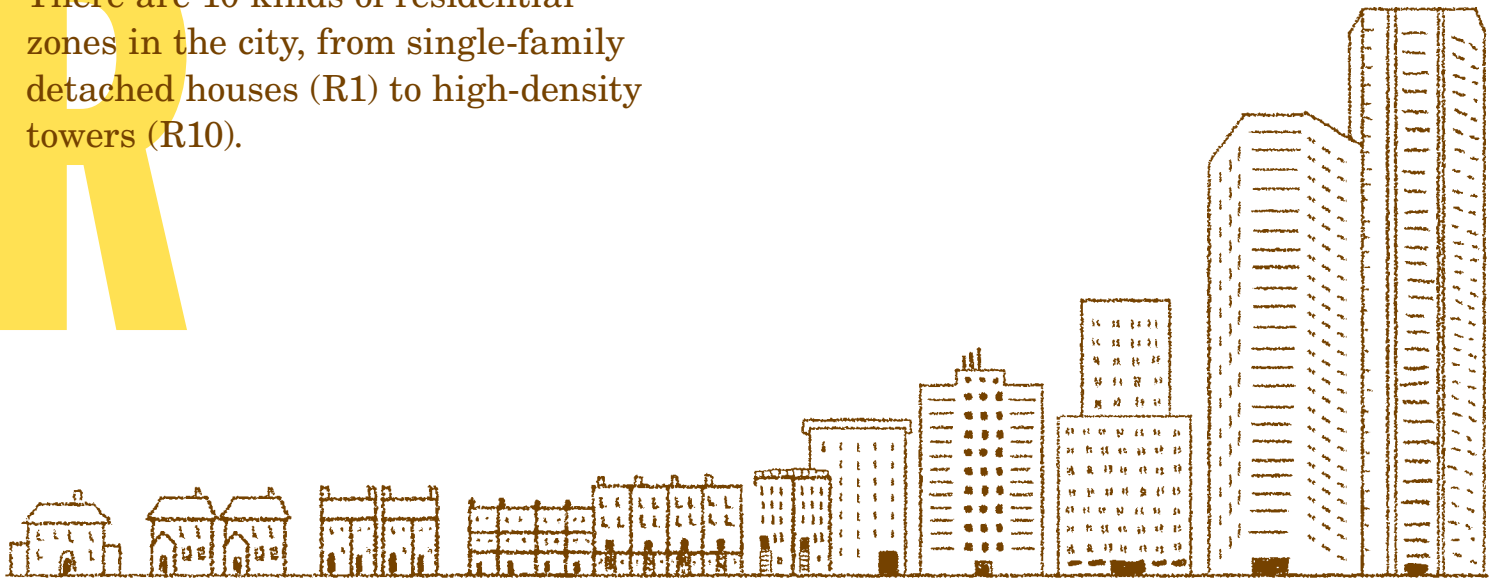
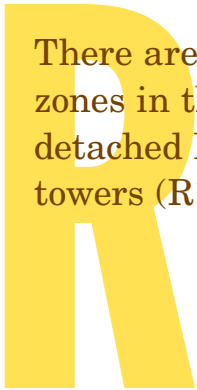

R1 **R2** **R3** **R4** **R5** **R6** **R7** **R8** **R9** **R10**



There are eight commercial zones—C1 through C8. You guessed it: different commercial zones allow different types of businesses.

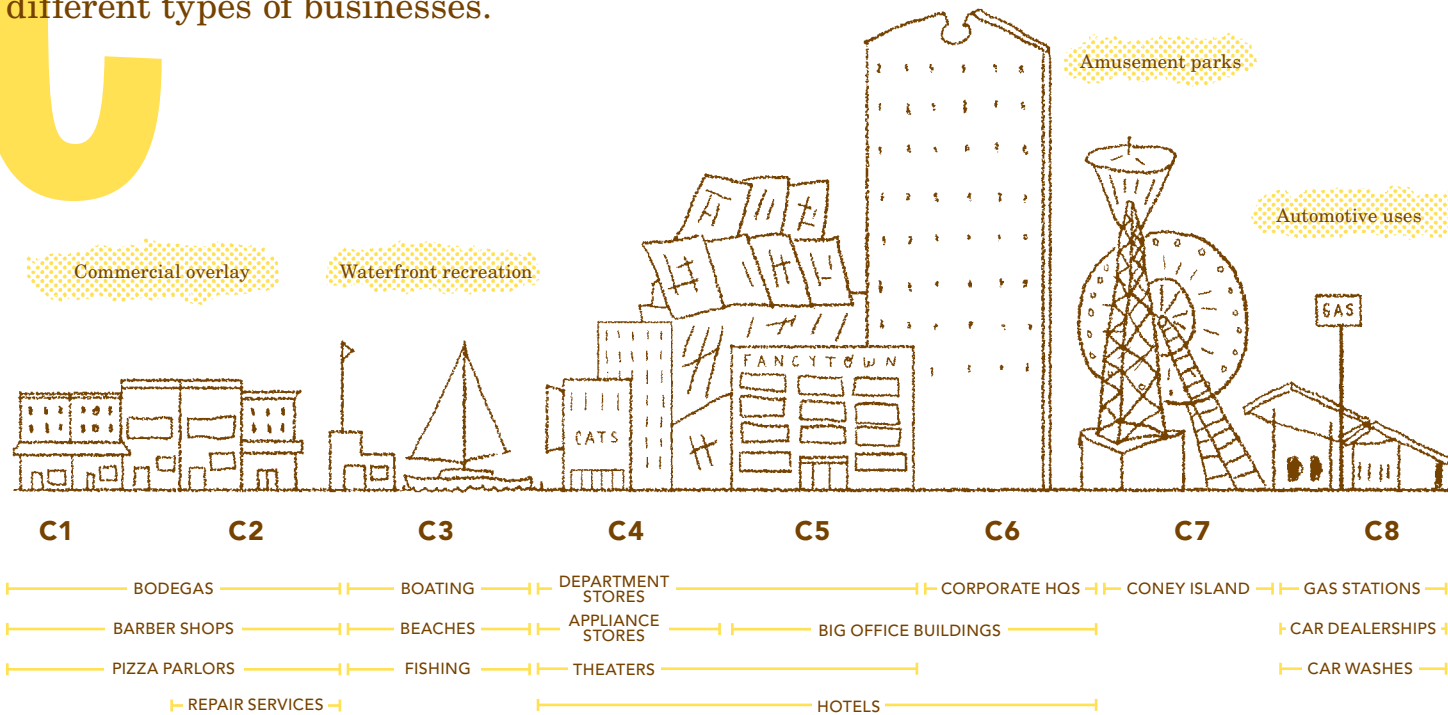

Most commercial zones also allow residential uses, but homes always have to be above businesses. Some residential districts have something called a 'commercial overlay'—this allows local retail, usually on the avenue or main commercial street in your neighborhood.

Generally a higher number indicates commercial uses that serve a larger area (with the exception of amusement parks and automotive uses). So C1 and C2 are for neighborhood services like bodegas and C5 and C6 are for central business districts and corporate headquarters.

Manufacturing and commercial uses aren't allowed in manufacturing zones. Usually the lower number means the use has less of a negative impact on surrounding uses.

M1 is often used as a buffer zone to keep heavier manufacturing uses from being located right next to residential or commercial uses.

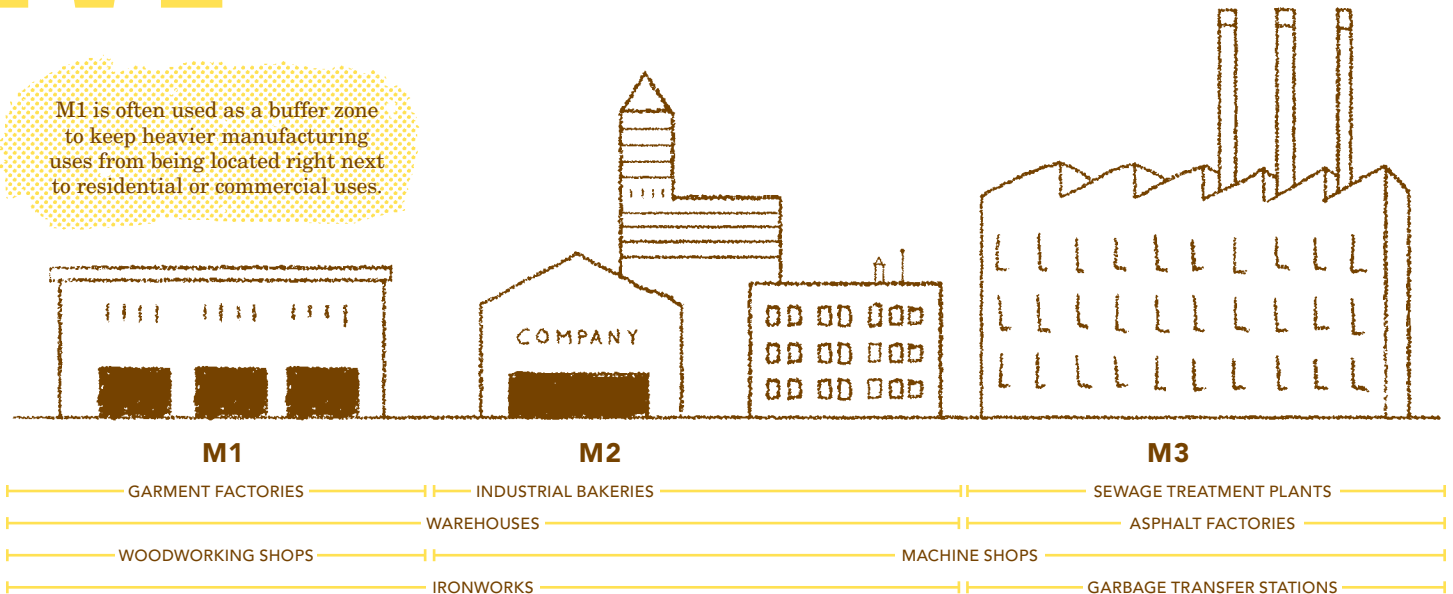

Special purpose districts

In the 1960s, new construction started to change the characters of some older neighborhoods. To allow for more specialized zoning rules that would apply only in certain areas, the city created “special purpose districts.”

In special purpose districts, the basic zoning rules apply, but there are also other rules to protect something unique about an area.

Here are some examples of special purpose districts that have been created and why:

LITTLE ITALY

PRESERVE CHARMING HISTORICAL DISTRICT

GARMENT DISTRICT

PRESERVE THE GARMENT-MAKING INDUSTRY, A HISTORICAL USE IN THE AREA

TIMES SQUARE

PRESERVE ITS TIMES SQUARE-ISHNESS, WITH REQUIREMENTS FOR THINGS LIKE GIANT ILLUMINATED SIGNS

BROOKLYN HEIGHTS

PROTECT THE VIEW OF MANHATTAN AND THE WATER

SHORE ACRES NATURAL AREA

PRESERVE THE NATURAL LANDSCAPE

125TH STREET DISTRICT

ENCOURAGE COMMERCIAL DEVELOPMENT, PRESERVE ROWHOUSES, AND STIMULATE CREATION OF LOCAL PERFORMING ARTS SPACES

One type of special purpose district is called a “mixed use district” (MX).

A “mixed use district” in NYC is one that used to be a manufacturing zone, but has been rezoned so that all uses are now allowed there, including residential and commercial. We’ll talk about this more in the section on rezoning.



These are some of the mixed use districts. The numbers in MX zones just refer to different neighborhoods. Each new MX gets a new number.

- MX-1 Port Morris
- MX-2 DUMBO
- MX-4 Flushing/Bedford
- MX-5 Red Hook
- MX-6 Hudson Square
- MX-7 Morrisania
- MX-8 Greenpoint/Williamsburg
- MX-9 Northern Hunters Point Waterfront
- MX-10 Atlantic and Howard Avenues
- MX-11 Gowanus
- MX-12 Borough Park
- MX-13 Lower Concourse
- MX-14 Third Avenue/Tremont Avenue



Garment District

“SHALL WE SAVE NEW YORK?” blared a full-page ad that ran in New York City in March of 1916. Did it have something to do with World War I? No, it was about the “Factory Invasion of the Shopping District.”

In the early 1900s, New York City’s garment industry outgrew piecemeal and the tenement sweatshops of the Lower East Side. It moved uptown to a bunch of new loft buildings north of 34th Street in what came to be known as the Garment District.

Fifth Avenue merchants were horrified. With the factories came hordes of immigrant laborers who flooded Broadway and Fifth Avenue at lunchtime and repelled the well-to-do shoppers that Bonwit Teller, Saks & Co, Gimbel Brothers, Lord & Taylor, and R.H. Macy depended on for their business.

The merchants formed the Fifth Avenue Association and decided on a three-pronged course of action: First, they would get their banker friends to stop funding new loft buildings. Second, they would organize a boycott. Third, they would push for zoning, a new idea that offered a way to stop industry from encroaching any further on their valuable commercial real estate.

Today, the city is attempting to use special zoning to preserve the Garment District, not to keep it at bay. Styles change!

How does zoning affect the size and shape of buildings?

Zoning law also guides the size and shape (sometimes called “bulk”) that buildings can be. It doesn’t say what a building should look like, but it does set up rules about how tall it can be, how it sits on the building lot, and how big it can be overall, depending on where it’s located.

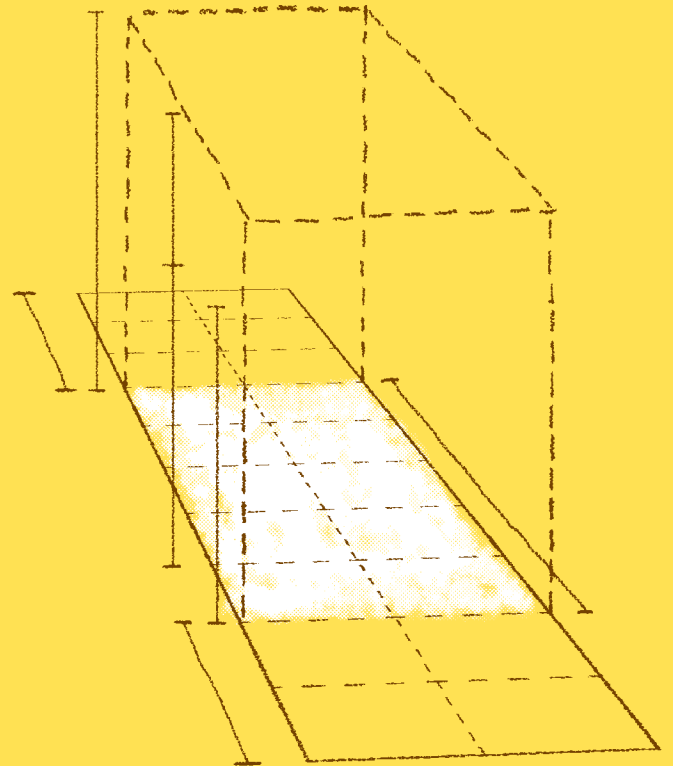

Why limit the size of buildings?

Well, because otherwise buildings would be a lot bigger! You can earn more money from a big building than you can from a smaller building in the same spot. A bigger building has more floor area to rent or sell. More floor area equals more money.

If every building was as big as owners and developers wanted it to be, a lot of neighborhoods would be overcrowded with big buildings. That's the situation that led to zoning law in the first place.

1,000 sf flr area
x \$2 sf rent/month

\$2,000
rent/month

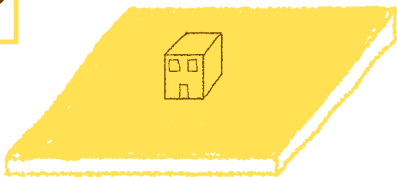

Hey, what's wrong with big buildings? Nothing!

Zoning can help make sure that neighborhoods with big buildings have the infrastructure—like subway stops and schools—needed to support lots of people.

20,000 sf flr area
x \$2 sf rent/month

\$40,000
rent/month

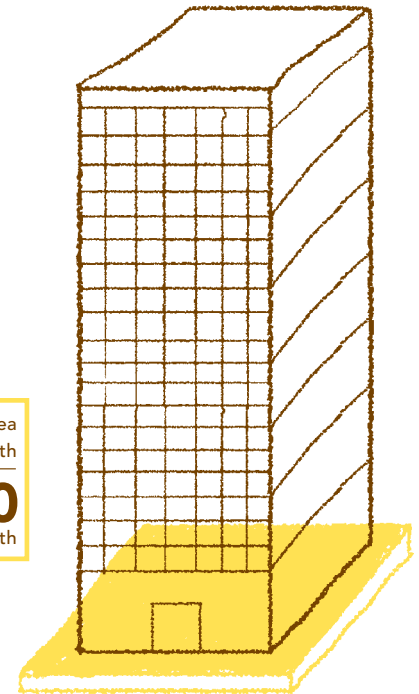

FAR : Floor Area Ratio

The main way zoning law limits size and shape is with something called F-A-R, or Floor Area Ratio.

It's the total square footage of all the floors of a building, divided by the total square footage of the lot it's on.

FAR FORMULA

$$\frac{\text{Total Floor Area}}{\text{Lot Area}} = \text{FAR}$$

*Small buildings
on big lots
have a low FAR.*

$$\frac{1,000 \text{ sf flr area}}{2,000 \text{ sf lot}} = \mathbf{0.5}$$

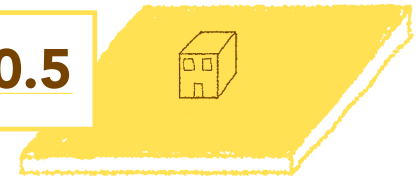

*Big buildings
on small lots
have a high FAR.*

$$\frac{20,000 \text{ sf flr area}}{2,000 \text{ sf lot}} = \mathbf{10.0}$$

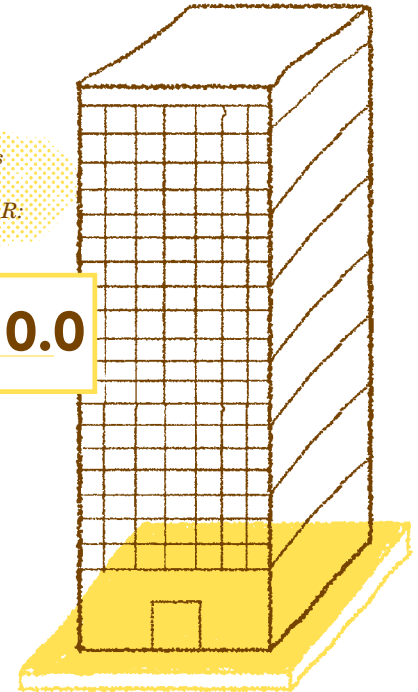

FAR : Floor Area Ratio

Each zoning classification in the city has a maximum FAR.

It limits how big a building can be in relation to the size of the lot it sits on.

Let's figure out some FAR!

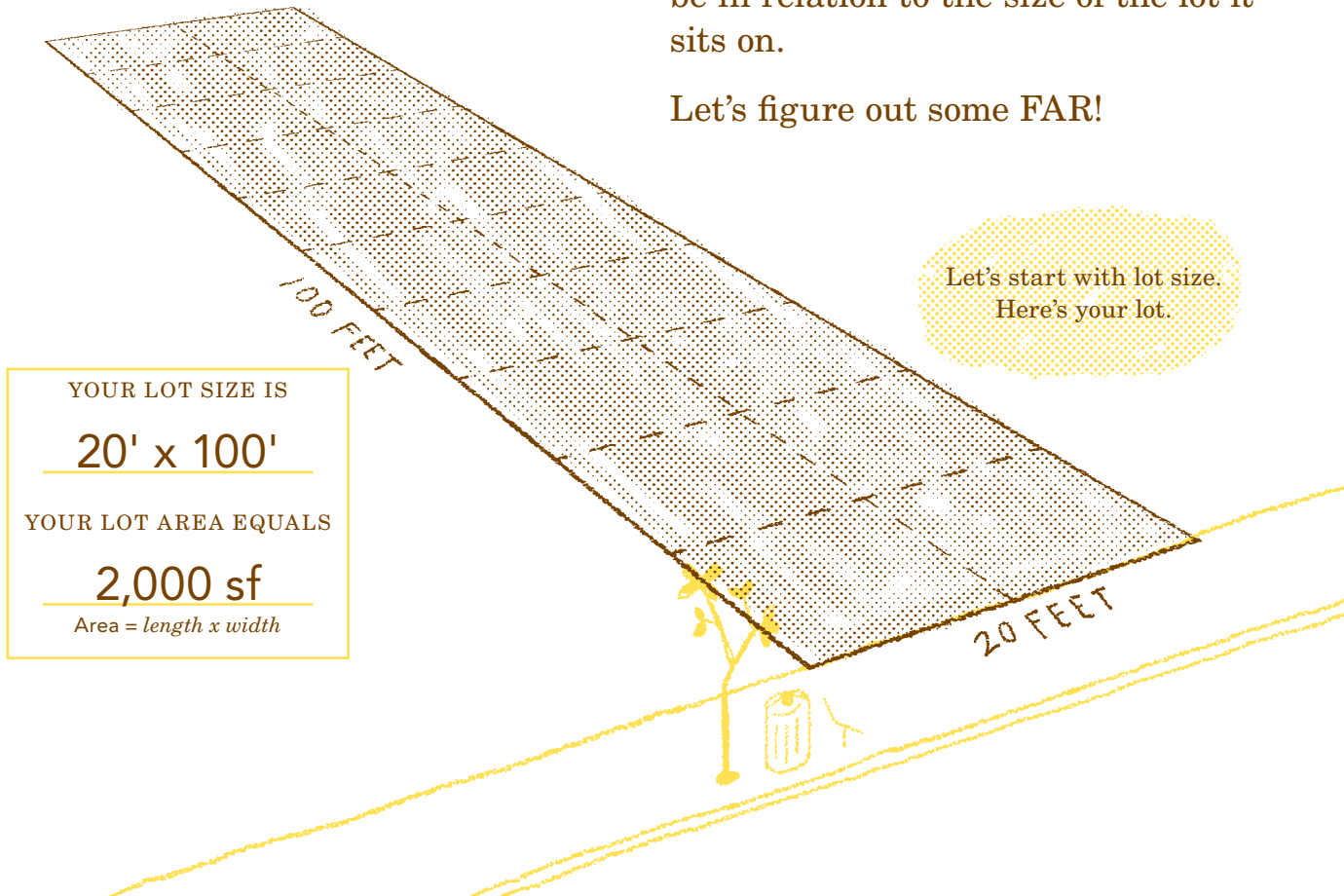

FAR : Floor Area Ratio

Say you build a one-story building that covers your whole 2,000 sf lot.

YOUR BUILDING

20' x 100'

YOUR BUILDING AREA

2,000 sf

Area = length x width

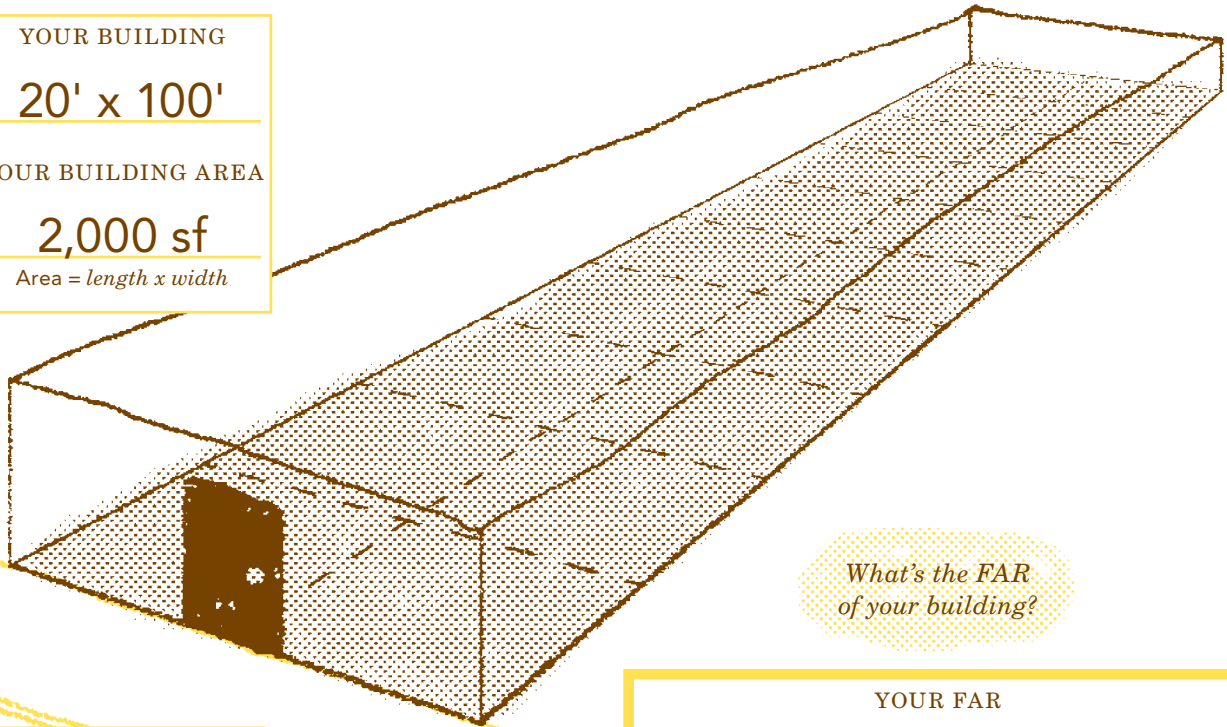

What's the FAR of your building?

LOT AREA

2,000 sf

YOUR FAR

$$\frac{2,000 \text{ sf flr area}}{2,000 \text{ sf lot}} = 1.0$$

FAR = total floor area ÷ lot area

FAR : Floor Area Ratio

Let's add some floors.

Say you build a 2 story building that covers half of your lot.

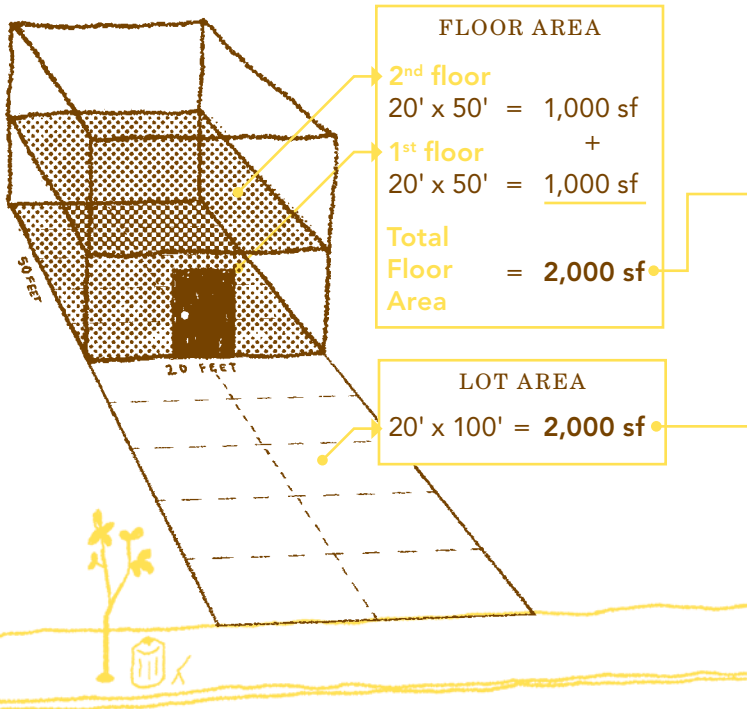

FLOOR AREA

2nd floor
 $20' \times 50' = 1,000 \text{ sf}$
 +
 1st floor
 $20' \times 50' = 1,000 \text{ sf}$
 Total
 Floor
 Area
 = **2,000 sf**

LOT AREA

$20' \times 100' = \mathbf{2,000 \text{ sf}}$

Here's how to

calculate the FAR.

YOUR FAR

FLOOR AREA

2,000 sf flr area

LOT AREA

2,000 sf lot

= 1.0

FAR = total floor area ÷ lot area

The FAR is still 1.0 even though the building looks different now.

FAR : Floor Area Ratio

Let's say the city increases your FAR from 1.0 to 2.0. You have the same lot, but you can make your building twice as big!

Look!, these two buildings look different, but they have the same FAR of 2.0.

YOUR FAR

$$\frac{4,000 \text{ sf flr area}}{2,000 \text{ sf lot}} = \mathbf{2.0}$$

$\text{FAR} = \text{total floor area} \div \text{lot area}$

FLOOR AREA

$$\begin{aligned} 1^{\text{st}} \text{ floor} &= 2,000 \text{ sf} \\ &+ \\ 2^{\text{nd}} \text{ floor} &= \underline{2,000 \text{ sf}} \end{aligned}$$

$$\begin{aligned} \text{Total Floor Area} &= 4,000 \text{ sf} \end{aligned}$$

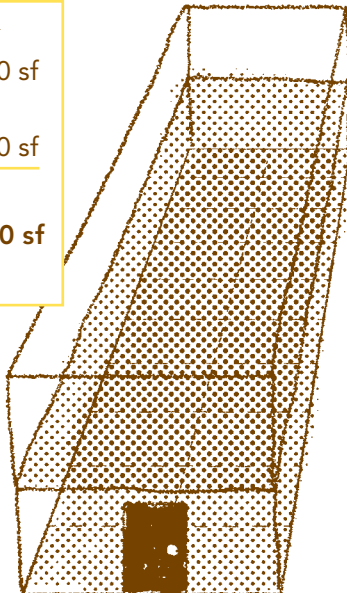

FLOOR AREA

$$\begin{aligned} 1^{\text{st}} \text{ floor} &= 1,000 \text{ sf} \\ &+ \\ 2^{\text{nd}} \text{ floor} &= 1,000 \text{ sf} \\ &+ \\ 3^{\text{rd}} \text{ floor} &= 1,000 \text{ sf} \\ &+ \\ 4^{\text{th}} \text{ floor} &= \underline{1,000 \text{ sf}} \end{aligned}$$

$$\begin{aligned} \text{Total Floor Area} &= 4,000 \text{ sf} \end{aligned}$$

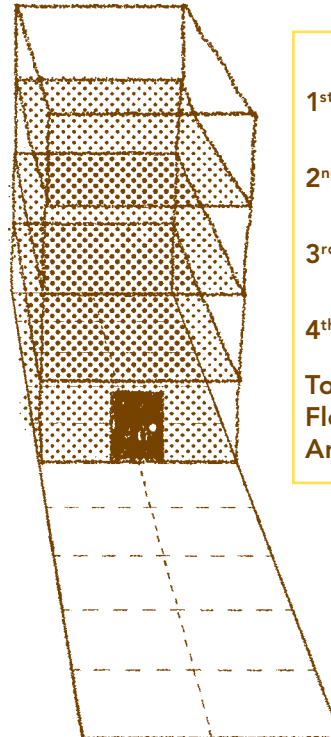

FAR : Floor Area Ratio

In New York, the maximum FAR allowed ranges from 0.5 for low density areas like Riverdale in the Bronx, all the way up to 15.0 for high density districts like Midtown Manhattan.

If your lot has a maximum FAR of 6.0, say, then you can make a building with six times the square footage of your lot. The bigger the lot, the higher your maximum square footage.

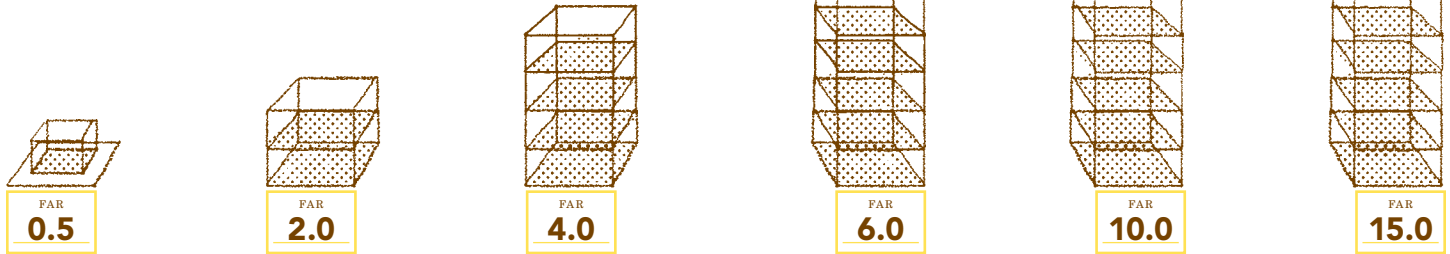

When you see an FAR like 1.0 or 4.0 or 10.0, one way to think of it is: that's the number of stories that a building covering the entire lot could be.



Equitable Building

Legend has it that outrage over the Equitable Building in Lower Manhattan led to the first zoning code in 1916.

Who was outraged? Why?

The building is pretty big. Elevators and steel construction made skyscrapers possible for the first time, and General T. Coleman du Pont, the gunpowder magnate who put up the money for the building, wanted to show off.

When it was finished in 1915, the Equitable Building became the largest office building in the world—over 13,000 workers in about 1.2 million square feet of space. It fills a whole city block and goes straight up 538 feet from the sidewalk, with no setbacks. New Yorkers cover in the seven-acre shadow it casts across the neighborhood.

Mostly it outraged other rich guys who owned buildings in the neighborhood. They were afraid that a glut of office space and the huge shadow would decrease the rents they could charge. As soon as they saw the first plan for the building, they tried to get the city to turn the lot into a park. When that didn't work, they became leading advocates of something called zoning—to make sure they didn't end up with a whole neighborhood full of giant buildings like the Equitable Building.

The Equitable Building became a historic landmark in 1978. So you can't build a new one, but you can't tear down the old one either!

Space between buildings

FAR isn't the only rule about size and shape.

If you could cover your whole lot with a building, and so could all your neighbors, there would be no walls with windows!

*Here's a city block without any open space, backyards, or shaftways.
Would you want to live here?*

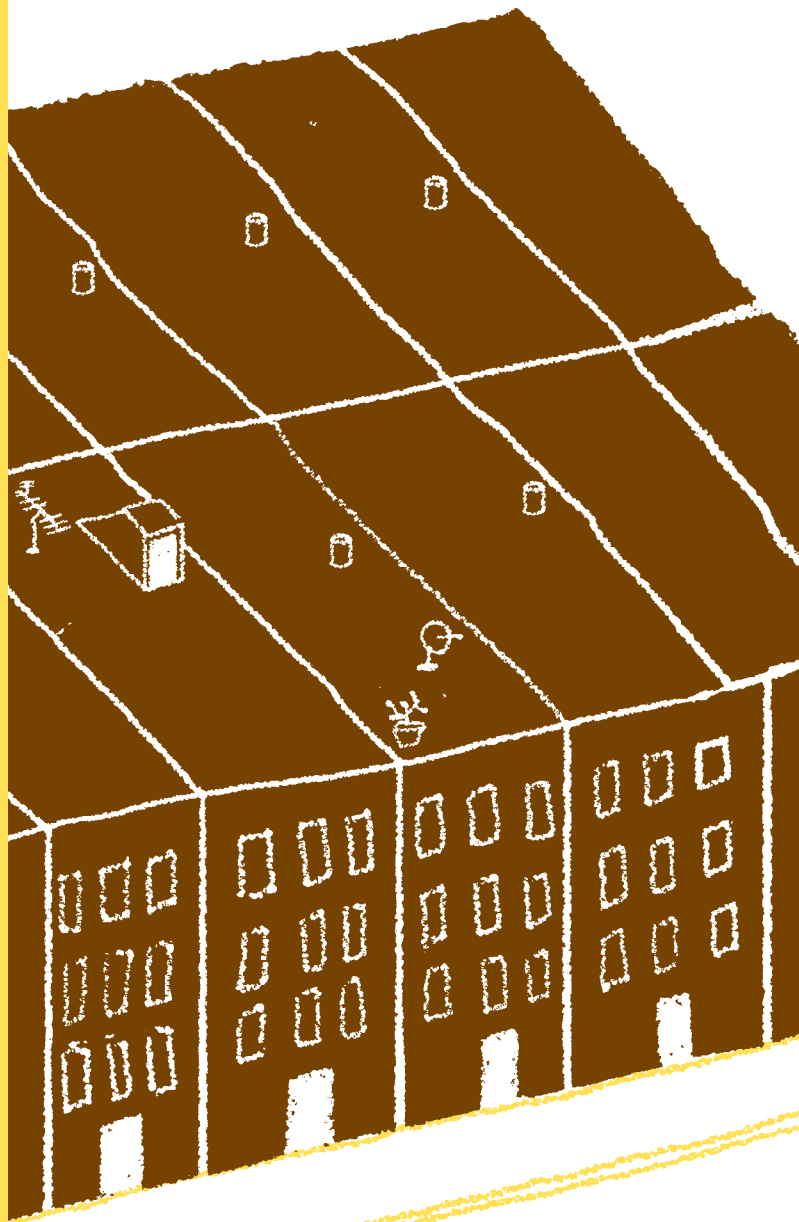

Lot coverage requirements

The city limits how much of a lot you can build on, so that there will be some space between buildings.

These are called “lot coverage requirements.” They usually say what percentage of the lot you can cover.

In most of NYC, you can cover a maximum of 60 to 70% of your lot, or 80% on a corner lot.

LOT COVERAGE

20%

LOT COVERAGE

60%

Here is your 2,000 sf lot again with an FAR of 1.0.

If your maximum lot coverage is 60%, your building can cover up to 60% (or 1,200 sf) of your lot.

The building on the right has the largest footprint allowed under a 60% lot coverage limit. Both buildings have the same FAR.

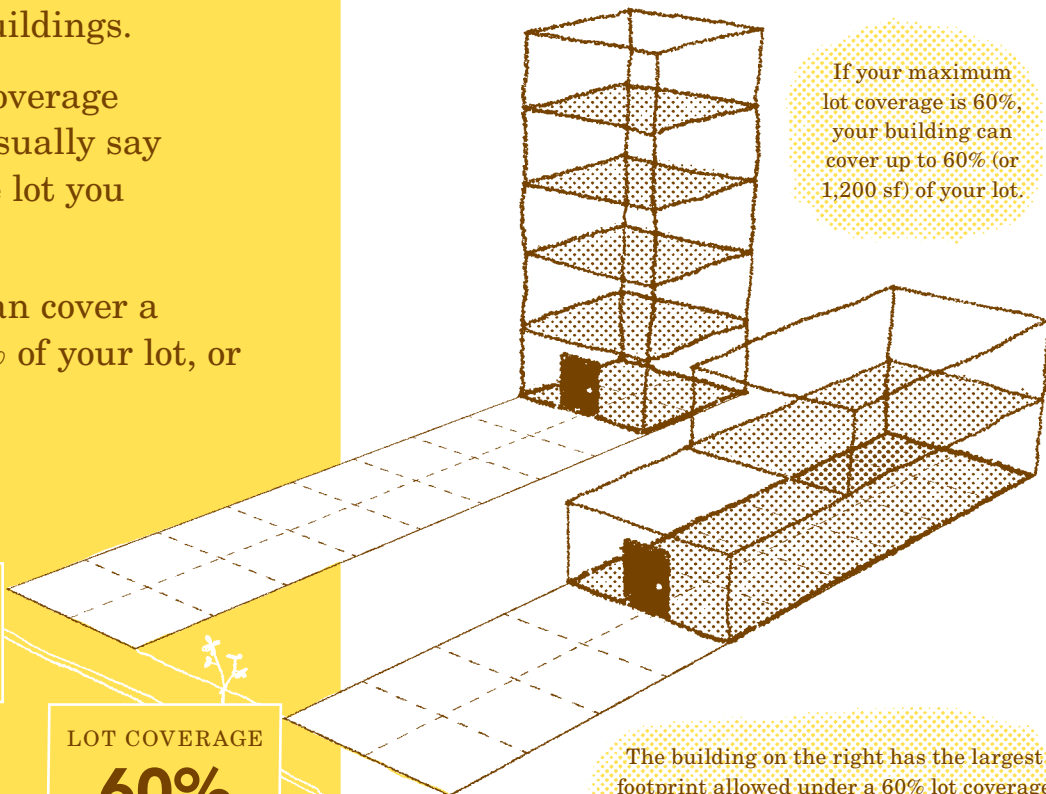

Yard requirements

Lot coverage limits help create some space between buildings, but the city also uses front and rear “yard” requirements to keep things from getting dangerous.

These don’t always look like what we think of as “yards.” They are just setbacks between the property line and where your building can sit.

In NYC, almost all residential districts require rear yards of at least 30 feet. Front yard requirements can be 5 feet to 20 feet. Detached houses also have side yard requirements of 2 feet to 15 feet depending on the district.

Back to your lot.

Let’s look at your 2,000 sf lot, with its FAR of 1.0, 60% lot coverage, and add a 30’ rear yard.

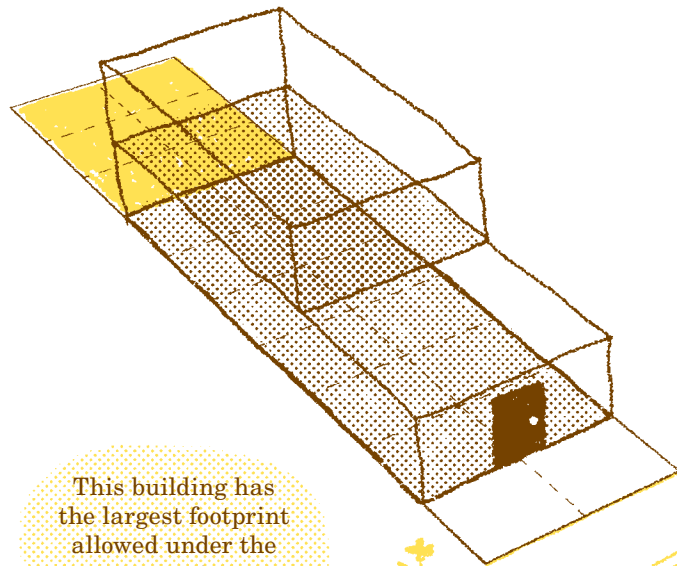

This building has the largest footprint allowed under the coverage requirements.

Base height/building height

Zoning law limits the heights of buildings. Many zones have two height limits.

“Base height” is the height of the front wall of the building.

“Building height” is the total height of the building at its tallest point.

Why are there height limits? What if your neighbor built a 30-story building next to your 4-story one? Cities use height limits to prevent huge buildings from literally overshadowing small ones, especially in lower-density areas.

Your building can't be taller than the maximum height limit in your zone, even if you haven't used up all of your FAR yet.

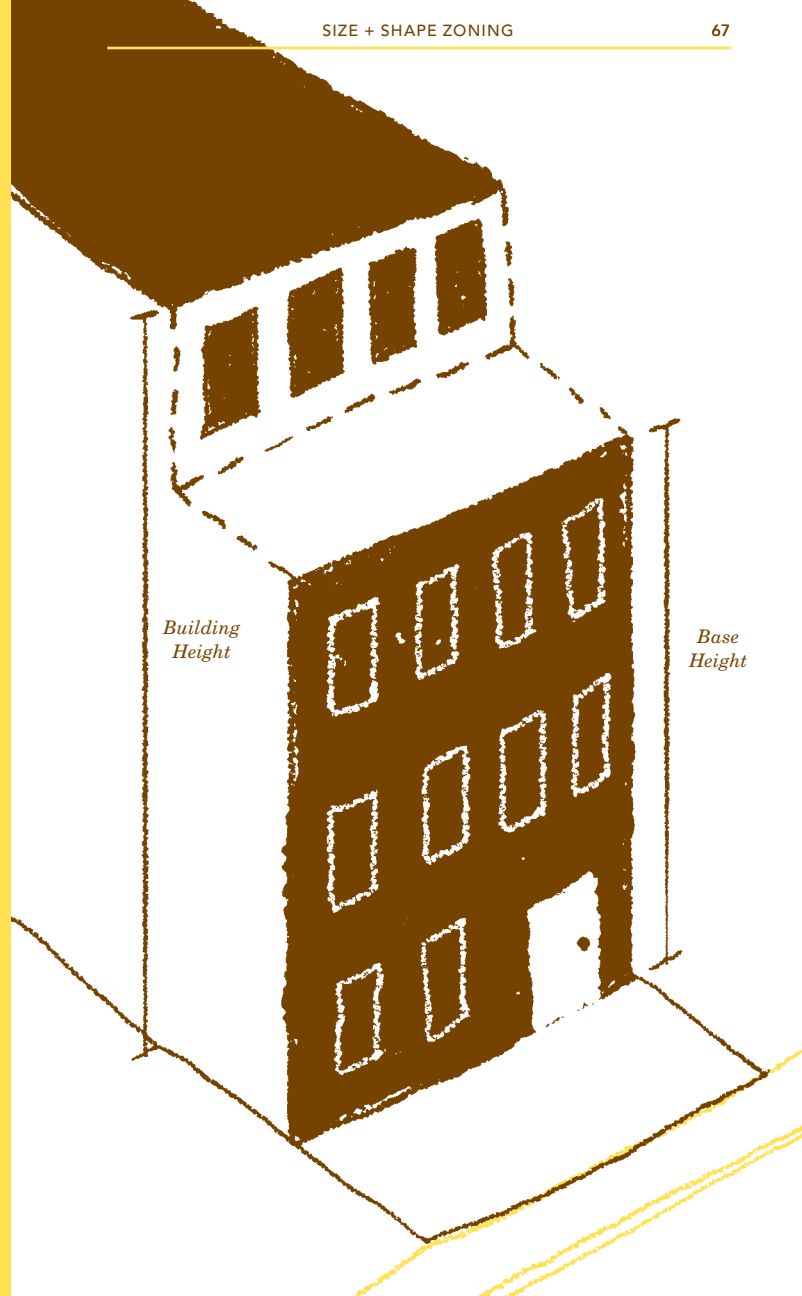

Height factor regulations

In the middle of the 20th century, urban planners reacting to the overcrowding of dense tenement neighborhoods thought it was healthier to build tall, skinny buildings surrounded by open space instead.

The zoning laws that encouraged this type of building are called “height factor” regulations.

They allow tall building heights and require low lot coverage—in other words, tall buildings with lots of space around them. The more open space around the building the taller the building can be.

Height factor regulations apply in zones that allow tall buildings: R6–R10.

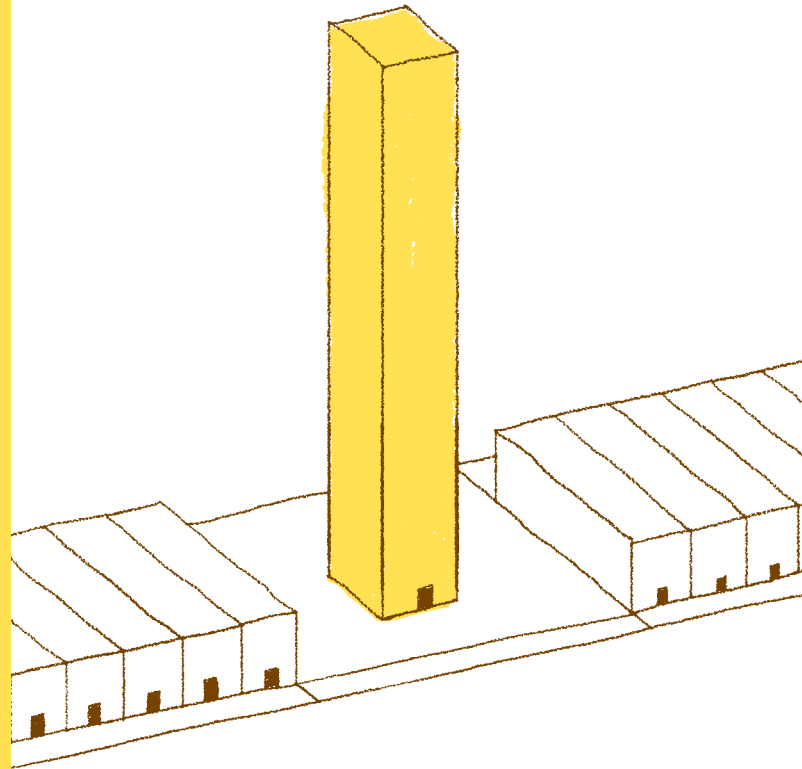

Contextual zones

Height factor laws led to some weird looking neighborhoods, though.

So the city created “contextual zones” in the 1980s. In these zones, the rules about size and shape and how buildings fit on a lot are based on existing buildings in a neighborhood. This is meant to make new buildings fit in better with the existing neighborhood “context.”

Contextual zoning is a common way for the city to try to protect the look and feel of a neighborhood.

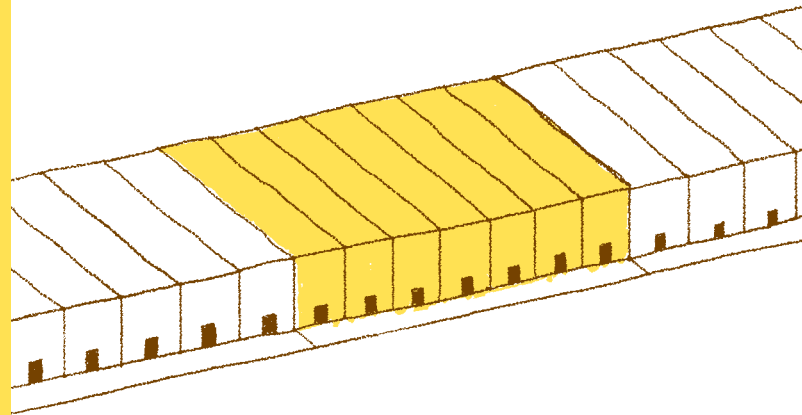

R6A

If you see a suffix
(A, B, D, or X),
it's a contextual zone!



Quality housing regulations

Contextual zoning is used in hundreds of NYC neighborhoods, from those with small buildings (R3A–R5D) to those with large buildings (R6A–R10X).

In regular height factor zones (R6–R10), where contextual zoning is not required, you can choose to follow the contextual zoning rules anyway. Often, the city will even give you an FAR bonus for doing that.

(To keep things complicated, the city calls these optional contextual zoning rules in large building zones, “Quality Housing” regulations.)

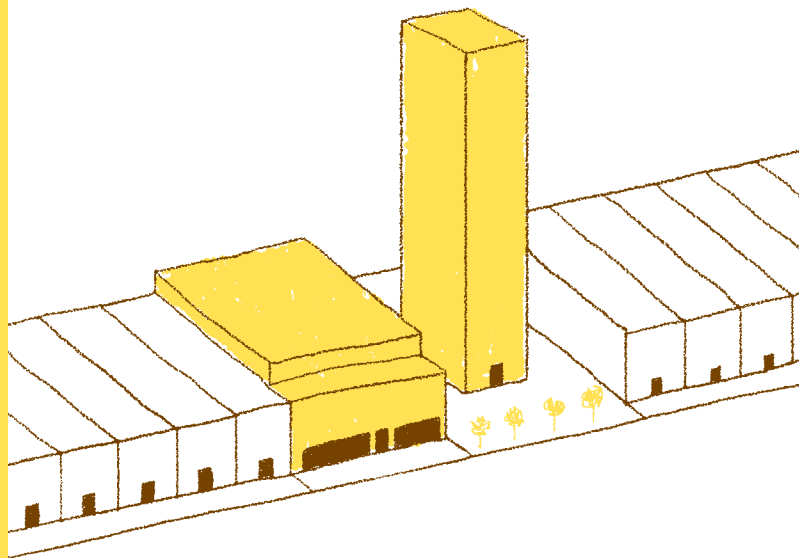

Zoning lot mergers

One way that developers can build bigger buildings is by combining their lot with a next door neighbor's.

Say you own a small building that hasn't used all its FAR, next door to a property owned by a someone who wants to build a big building.

They can pay you to combine your lot with theirs so they can use your FAR on their building.

You still own your building, but you can't make it any bigger because your neighbor has used up all the FAR on the lot you share.

This is called a "Zoning lot merger" and it's a common way to increase FAR.

BEFORE MERGER

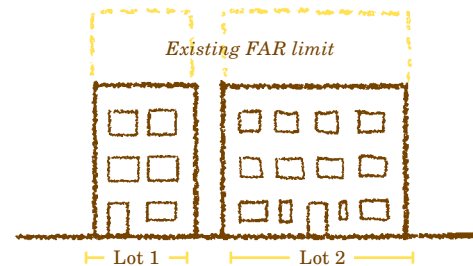

AFTER MERGER

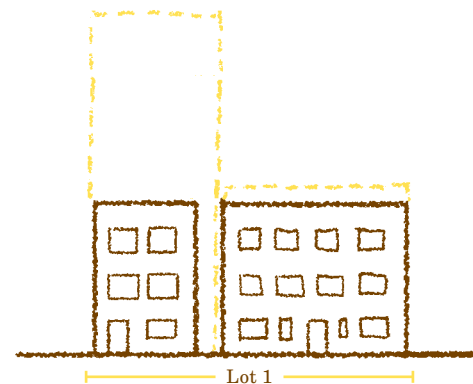

In some places in the city, you can buy the extra FAR from a building across the street or down the block. This is called "Transfer of Development Rights (TDR)"



Towers in the Park

In the cities of the future, people will live in identical apartment towers surrounded by green space and spread evenly across the city. Busy and messy mixed-use street scenes will be a thing of the past. People will zoom from home to factory and back on dedicated, elevated superhighways.

That's what French architect Le Corbusier thought in 1920. These avant-garde ideas were surprisingly influential on American urban planning. They even found their way into New York City's 1961 Zoning Resolution, which revamped the 1916 code to emphasize open space and make the city more car-friendly.

The style of building Le Corbusier envisioned came to be known as "Towers in the Park." Can you think of any buildings that look like that? That's right: public housing in New York City, Chicago, St. Louis, and other cities across the country. They were one big experiment in modernist architecture. From the 1940s through the 1960s, the federal government funded huge "urban renewal" projects that replaced so-called "slums" of tenement apartments with high-rises and freeways.

Le Corbusier left his mark on fancier buildings as well—Lever House on 53rd Street and the United Nations Headquarters, for example. Those buildings are more like slabs-in-the-plaza than towers-in-the-park, but it's the same general idea.

These ideas are pretty controversial today.

What is a rezoning?

Every piece of land in the city has a zoning designation. But zoning can change. When it does, it's called a rezoning.

You can propose a rezoning of your neighborhood, and so can the city, or a developer.

People sometimes refer to a particular rezoning as an “upzoning” if it increases the FAR or allowable building area in a neighborhood. A “downzoning” is a rezoning that decreases the FAR or allowable building area.



Upzoning

Upzoning usually happens in places where the city wants to promote development. The scale of the neighborhood is probably going to increase, along with the number of people and services.

BEFORE UPZONING



The buildings could be bigger in this neighborhood.

AFTER UPZONING



Now, the neighborhood has changed; there are a lot more people living and doing business here.

Downzoning

Downzoning usually happens in neighborhoods where existing buildings are mostly below the current allowable FAR. A neighborhood might propose a downzoning to protect the existing neighborhood scale.

BEFORE DOWNZONING



Buildings in this neighborhood have unused FAR.

AFTER DOWNZONING



A downzoning will make sure these buildings don't get torn down and replaced with bigger ones.

Up or down?

It can be hard to tell whether your neighborhood is being upzoned or downzoned. Most rezonings increase FAR in some parts of a neighborhood and decrease it in others.

BEFORE

Lots in this area have unused FAR.

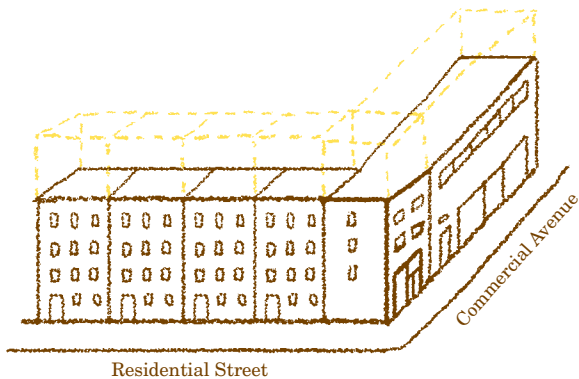

In recent years the city has proposed many rezonings that increase FAR close to transit stations and decrease it slightly in surrounding blocks. The idea is to direct development to where there is more infrastructure to support it.

AFTER

Some lots are downzoned and others are upzoned.

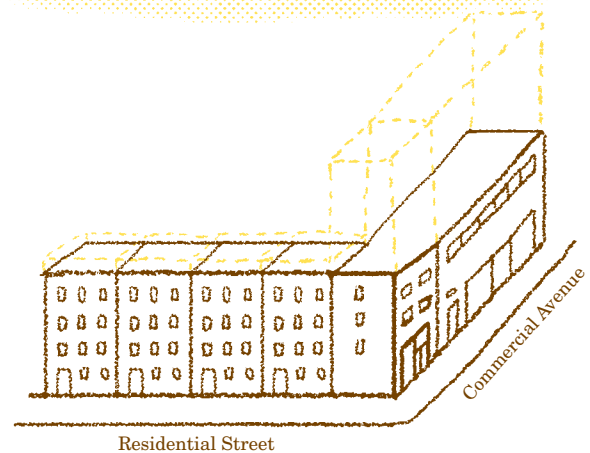

Rezoning questions to ask

WHAT AREAS WOULD GET INCREASED FAR?

Why are those areas targeted for more development?

What improvements will be made to address increased population?

WHAT AREAS WOULD GET DECREASED FAR?

Will lower FAR help preserve the neighborhood?

Is it a contextual rezoning?

HOW WILL THAT AFFECT MY COMMUNITY?

Out with the old

Small changes in FAR might not result in a very different neighborhood. But big changes can result in pressure to tear down older, smaller buildings.

Here's a rule of thumb:

IF FAR INCREASES BY
50% OR MORE

THERE IS PRESSURE TO
DEMOLISH AND BUILD
NEW, LARGER BUILDINGS

Rezoning for use

Sometimes a neighborhood rezoning changes the allowable uses in a district.

In NYC, the most common type of use rezoning is one that changes a manufacturing (M) district to a “mixed use” (or MX) district. A change from M to MX allows existing manufacturing to stay, but also allows new residential and commercial uses to come in to the area, and makes things like illegal loft conversions in old manufacturing buildings legal.

BEFORE

A productive manufacturing zone.

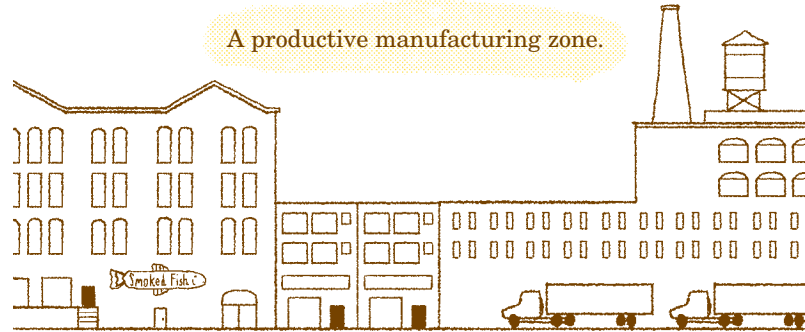

AFTER

A bustling mixed use zone.



“Mixed use” is a term some people use to describe buildings that have commercial uses on the first floor with residential uses on upper floors. But it means something different in NYC zoning!

Mixed use rezoning

“Mixed use” rezonings usually happen in areas the city thinks are “underused”—in other words, where there is demand for development. These are often neighborhoods where people are already starting to move to, like Tribeca in the 1970s and Greenpoint in the early 2000s.

Between 1960 and 1989, New York went from around 1 million manufacturing jobs to just 369,000.

*If you owned this building,
what would you do?*



Developers and some city officials think other kinds of development should be allowed in the declining manufacturing areas and that rezoning is a good way to encourage development and create more housing.

Other people, including some city officials, think manufacturing jobs are an important part of the city’s economy and that rezonings make it harder for manufacturers to afford to stay in the five boroughs.

How can zoning make my neighborhood better?

A lot of zoning focuses on the size and shape of buildings and how they can be used. But the zoning code includes other provisions that can affect how—and how quickly—neighborhoods grow and change. This section lays out some of the tools you can use to encourage changes that reflect your community’s goals. Some of these tools are officially part of the zoning process, while others are separate from zoning, but can work with zoning to shape your community.

ANTI-HARASSMENT RULES

HOW IT WORKS

In areas where proposed development is expected to contribute to rapid and significant increases in rent prices, anti-harassment rules can be used to at least slow the impact. These rules allow a tenant to take his/her landlord to court for a history of harassment or if the landlord tries to force him/her to move out of the building.

The special district rules require community organizations to be notified when a new development is going up and give those community organizations a chance to check up on landlords. (There’s also a law called the Tenant Protection Act that makes it illegal for a landlord to harass tenants anywhere in the city. But that act only covers harassment that is currently occurring and does not notify community organizations of new developments.)

WHAT IT’S GOOD FOR

Protecting affordable rents in neighborhoods where housing prices are rapidly increasing

WHEN IT DOESN’T WORK

Because of the Tenant Protection Act, the city doesn’t think communities need these rules. So they are very difficult to get these days.

They have to be included as a part of a special purpose district and aren’t available other places.

WHERE IT’S BEEN USED

Greenpoint/Williamsburg, Hell’s Kitchen

ANTI-DEMOLITION RULES

HOW IT WORKS

Anti-demolition rules make it illegal for a landlord to tear down a building that is in good condition.

By preserving older, rental buildings, anti-demolition rules can preserve affordable rents for tenants. Buildings with smaller apartments and fewer of the conveniences of newer buildings will likely have to charge lower rents than newer buildings, even in gentrifying areas.

WHAT IT'S GOOD FOR

Preserving neighborhood character and buildings; In some situations it can help preserve affordable rents, but in some cases it can do the opposite

WHEN IT DOESN'T WORK

In areas where housing demand is already great and there is less new construction (like the West Village, for example), smaller older buildings can still become very expensive. In those situations, allowing demolition might actually lead to the creation of more housing units and more affordable housing prices. These rules have only been used in special purpose districts and not included as parts of other rezonings.

WHERE IT'S BEEN USED

West Chelsea Special District

INCLUSIONARY ZONING

HOW IT WORKS

In areas where housing costs are increasing and where there is development interest, the city designates zones for the Inclusionary Housing Program.

In these zones, developers can make their buildings up to 33% bigger, if they preserve 20% or more of their buildings for affordable housing. The city calls this "incentive zoning" because they are offering developers a bonus in exchange for building something the community needs.

This can work well in areas where there is a lot of developer interest. The more buildings that go up in an area like this, which is usually one where rents are going up quickly, the more affordable units that are created.

WHAT IT'S GOOD FOR

Creating housing units affordable to families with incomes between 80% and 125% of median family income, in areas with high demand for housing

WHEN IT DOESN'T WORK

Inclusionary zoning requires a hot real estate market and doesn't work as well in areas where housing demand is not so high that developers feel like they need the bonus. For example, on 4th Avenue near Park Slope in Brooklyn, several large apartment buildings have gone up but almost none have used the inclusionary housing bonus. So very little affordable housing is actually created.

WHERE IT'S BEEN USED

Greenpoint-Williamsburg, Parts of Chelsea and Bedford Stuyvesant, 4th Avenue in Brooklyn, and lots of other places across the city

MANDATORY AFFORDABLE HOUSING

HOW IT WORKS

Inclusionary zoning creates an incentive for developers to provide affordable housing units in exchange for a development bonus. The developers don't always take the bonus.

Some communities have advocated for mandatory affordable housing. Instead of just providing an incentive, this would require developers to include affordable units in their projects. This could apply to projects over a certain size and in designated areas.

WHAT IT'S GOOD FOR

Ensuring that new developments will include affordable units. And if these units are required to be permanently affordable, then affordable homes will be added for generations to come.

WHEN IT DOESN'T WORK

No one in NYC has used this yet. Developers will likely be opposed to it.

WHERE IT'S BEEN USED

Nowhere in NYC, but other cities, like Cambridge, MA, and San Francisco, CA, have used this for years

INDUSTRIAL BUSINESS ZONES

HOW IT WORKS

These are not formally part of the zoning process, but the city has promised to keep IBZ areas as manufacturing zones. This could change and individual parcels of land within IBZs have already received zoning variances allowing non-manufacturing uses.

There is a city tax credit for manufacturing businesses that relocate to IBZs, which helps preserve the viability of manufacturing in these areas.

WHAT IT'S GOOD FOR

Preserving manufacturing uses in the city

WHEN IT DOESN'T WORK

When individual variances undermine the overall designation

WHERE IT'S BEEN USED

Long Island City, East New York, Port Morris

DISTRICT IMPROVEMENT BONUS

HOW IT WORKS

Some neighborhoods with special districts have created District Improvement Bonuses (DIBs). Developers can pay money to a city fund in exchange for extra FAR. The fund is then used to pay for things that benefit the neighborhood or that offset the impacts of increased population, like subways, sidewalks, or sewers.

WHAT IT'S GOOD FOR

Ideally, it will help pay for services in neighborhoods with lots of people. A lot of different types of services could be paid for with DIBs.

WHEN IT DOESN'T WORK

This is a relatively new program, so no one knows if it really works yet. It depends on a hot real estate market where developers want to pay extra to build bigger. There is also no guarantee the money will be spent effectively.

WHERE IT'S BEEN USED

Hudson Yards

INDUSTRIAL PRESERVATION AREAS

HOW IT WORKS

In the Garment District, special preservation rules have limited the number of areas in which competing land uses (including hotels, residential, and commercial uses) can be developed. Businesses located on the cross streets in the area have to be related to the garment industry.

WHAT IT'S GOOD FOR

Preserving manufacturing in areas with development pressure

WHEN IT DOESN'T WORK

This is an unusual protection and most likely reflects the economic power of the fashion industry in NYC. Communities have had difficulty securing similar provisions in other manufacturing areas. Some of the building owners in the Garment District think it costs them money by keeping them from renting to whomever can afford to pay the most.

WHERE IT'S BEEN USED

Garment District

ARTS, ENTERTAINMENT, AND OTHER DISTRICTS

HOW IT WORKS

In the 125th Street area in Harlem, a special district was created to build on the area's history as a performing arts district. Developers are allowed to build larger buildings in exchange for creating ground floor space for nonprofit visual or performing arts groups.

WHAT IT'S GOOD FOR

Encouraging arts spaces, and supporting nonprofit arts groups

WHEN IT DOESN'T WORK

When there aren't enough organizations to fill the spaces, they will usually end up used for other purposes.

WHERE IT'S BEEN USED

125th Street in Harlem

ENHANCED COMMERCIAL DISTRICTS

HOW IT WORKS

The city has added a new type of special district called an "enhanced commercial district," which limits the amount of ground floor retail space that can be occupied by banks, offices, lobbies, and other "non-active" uses. This is meant to encourage a diversity of businesses but also to help make sure that retail streets include lots of pedestrian activity, even after 5 pm.

These districts also include rules about how much glass is required, especially on the ground floor. The idea being that the more glass, the more active (and safer) the street is.

One enhanced commercial district on the Upper West Side limits the maximum size of a storefront as a way to prevent banks from filling up entire blocks.

WHAT IT'S GOOD FOR

Encouraging an active street environment and a diversity of businesses

WHEN IT DOESN'T WORK

This is a fairly new type of protection. It remains to be seen how well it works.

WHERE IT'S BEEN USED

Parts of the Upper West Side, Broadway in Bedford-Stuyvesant, 4th Avenue in Brooklyn

TREES & GREENSPACE

HOW IT WORKS

As of 2008, all zoning districts require a street tree for every 25 feet of property facing the street. The requirement kicks in with new developments or significant enlargements. But some special districts have more specific planting requirements.

In areas with large developments, developers are sometimes asked to provide additional parks as a public benefit, and the city has committed to building additional parks in areas of major rezonings. For example, in Greenpoint/Williamsburg, the city committed to building 10 acres of parks as part of the rezoning.

WHAT IT'S GOOD FOR

Creating outdoor public space, especially in areas with significant new development

WHEN IT DOESN'T WORK

Not all parks and greenspace are the same, and sometimes parks can be located in parts of districts that are more accessible to some residents than others. It can take a very long time for the city to build parks it has committed to, and as time passes priorities may change.

WHERE IT'S BEEN USED

Greenpoint/Williamsburg

PARKING RULES

HOW IT WORKS

There are a few pieces of the zoning code that affect how much and where parking goes in a neighborhood.

Every district has some rules about the number of off-street parking spaces required for new developments. Some of these rules define the minimum amount of spaces per district, but there are some rules limiting the maximum number of spaces as well. The number of off-street parking spaces in a neighborhood can have big impacts on how much traffic there is, and your community can push to have the limits adjusted. For example in Rockaway residents wanted more parking available, while in the West Clinton rezoning, they wanted less.

WHAT IT'S GOOD FOR

Ideally parking rules are calibrated to community needs

WHEN IT DOESN'T WORK

In some places, if you require more parking, people will drive their cars more, and create more traffic.

WHERE IT'S BEEN USED

These apply in all districts, but you can push for different limits in your community

The big picture

Whether your community proposes a rezoning or is reacting to a city-proposed rezoning, you can advocate for provisions that help create or protect positive characteristics of your neighborhood and discourage negative ones.

There are three ways to do this:

1. Before a rezoning is proposed, by creating a community-led 197-a plan
2. As part of the rezoning process, using the Environmental Impact Statement
3. By advocating for the creation of a special district as part of a rezoning.

197-a PLANS

HOW IT WORKS

Many cities create city-wide “comprehensive plans” to guide growth in their communities. These plans help coordinate housing and commercial development with the services they require like schools, transportation, sewers, and garbage collection.

NYC hasn’t made a comprehensive plan since 1969, and instead uses zoning to address growth. But that means sometimes other services aren’t considered.

Communities can make their own local plans called 197-a plans. The city provides a few resources to help you produce one but it is a long process and requires a serious commitment by the community to make sure it is carried out.

WHAT IT’S GOOD FOR

Showing the city that there is broad support for a planning vision; documenting issues that need to be addressed in future development of an area; highlighting issues that should be considered in an Environmental Impact Statement

WHEN IT DOESN’T WORK

Unfortunately, the city is not bound by 197-a plans, and in the worst-case scenario, a community can put together a 197-a plan that is ignored in future rezonings, as happened in Greenpoint/Williamsburg in the early 2000s.

WHERE IT’S BEEN USED

Greenpoint/Williamsburg, Brooklyn, Morningside Heights

ENVIRONMENTAL REVIEW

HOW IT WORKS

Every rezoning proposal, as well as any major development project, requires an environmental review. It's a report that describes all the different kinds of impacts that the proposed project will have on a community—including things like traffic, noise, parking, sewers, economic conditions, public health, and more.

Part of the review might be an Environmental Impact Statement (EIS) which includes public comments and suggestions of other impacts the proposal might have.

The EIS is important because impacts that are added to the "scoping" list at the beginning of the process can be brought up later in public hearings to hold the project accountable.

WHAT IT'S GOOD FOR

Making sure that the city bodies responsible for approving rezoning and development proposals recognize your community's concerns

WHEN IT DOESN'T WORK

Even if major impacts are included, a project may still be approved over community objections. The EIS only lists impacts, it doesn't say anything has to be done about them.

WHERE IT'S BEEN USED

In every rezoning and many large development proposals

SPECIAL PURPOSE DISTRICTS

HOW IT WORKS

There are only three land use categories in NYC zoning, but for anything outside the standard zoning categories, there are special districts. (See page 36)

When city agencies, developers, or communities want to include non-standard provisions in a rezoning, they can ask for special districts.

WHAT IT'S GOOD FOR

Getting non-standard provisions (including many of the ones listed in the previous section) included in a rezoning.

WHEN IT DOESN'T WORK

Anyone can advocate for a special district, so you have to look carefully at the provisions to know if you think it's creating positive or negative change for your community

WHERE IT'S BEEN USED

Lots of places. There are special districts for things like natural areas; large developments like Hudson Yards; all of the mixed use zones (like Greenpoint-Williamsburg); historic areas like Little Italy; theater zones like 125th Street in Harlem; and many more

Workshop instructions

In
outcomes



Using the Zoning Toolkit

Public participation works best when everyone understands the basic laws, policies, and jargon they will hear at a public meeting.

The Zoning Toolkit can help you facilitate conversations about zoning rules and how they affect your neighborhood and the city as a whole. The activities are designed to help people easily understand some of the core ideas behind the complexities of zoning. Once the group you're working with understands the basics, you might want to plug these tools into a broader discussion about how you think things should work or what you think should happen in your neighborhood. The tools themselves don't make arguments for or against different zoning decisions, but they can help you make yours.

The activities are flexible. You don't have to do them all. You can mix and match to focus on the issues more important to you and your group or neighborhood.

The topics of the activities are:

1. Why Zoning?

Use Zoning

2. What is "Use Zoning"?

3. How Does Mixed Use Rezoning Work?

Zoning for Size & Shape

4. How Does Size & Shape Zoning Work?

5. How Does a Size & Shape Rezoning Work?

6. What Is Inclusionary Zoning?

You can do all of the activities in order, or you can do Use Zoning or Zoning for Size & Shape on their own. The activities build on each other, so you will probably want to do the introductory activities (like #1, #2 and #4) before you do the more complicated ones (like #3, #5, or #6).

This guide is arranged so that things you might say out loud are in *italics*. The rest of the text provides information you'll need to be familiar with to lead the workshop. (You don't have to memorize it, just use this guide to help you.)

WHAT'S IN THE BOX?

Game Board

The game board has two sides:



Zoning the City

This side is used for activities about land and building use. (Activities 1–3)



Zoning the Block

This side is used for the size & shape zoning activities. (Activities 4–6)

Infrastructure Tiles

The kit includes green and blue plastic infrastructure pieces to be used on the “Zoning the City” side of the board.

Building Blocks

The kit includes colored block in 2 sizes and 4 colors. Participants will use these to build individual buildings on the “Zoning the Block” side, and to build city blocks on the “Zoning the City” side.

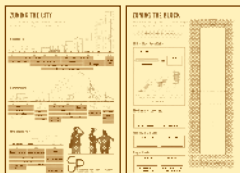

Individual Activity Sheets

Hand these out to the participants so they can follow along, take notes, and take the information home with them. Like the game board, one side is labeled “Zoning the City” with information

about use zoning and the other is labeled “Zoning the Block” with information about size & shape zoning. (You can make more copies by downloading the file here: welcometocup.org/zoning)

GETTING STARTED

The activities work best for groups of 5 to 14 people. Fewer than that and it can be hard to see the patterns that result from the decisions people are making. If you have fewer than 5, you may want to ask participants to make multiple buildings on the “Zoning the Block” side of the board. With more than 14 people, it can be hard for everyone to reach the board. You might ask people to team up in this case. Or you can find out how to purchase additional blocks or gameboards for the activities here: welcometocup.org/zoning

1. Place the game board in the center of a table where all the participants can reach it.
2. Give every participant an activity sheet. Have some pens or pencils ready for people to take notes with.
3. Hand out red, yellow, and blue colored blocks to each participant, making sure each person gets some of each color and all participants have about the same number of blocks. Every participant should get at least 10 blocks. Additional setup is addressed in the activities.
4. Have fun!

Activity 1

WHY ZONING?

Objective This is an introductory activity for zoning in general. The group will get a sense of why zoning law exists by creating and analyzing a city created without zoning.

Time 10 minutes

Setup Flip the game board to the “Zoning the City” side:



Be sure everyone has both some 2x2 and 2x4 blocks. Keep about 10 blocks aside for yourself to build an “asphalt plant” in step 4. For this activity it doesn’t matter what color blocks are used.

1. BUILD WHATEVER YOU WANT!

SAY *You all have some bricks, a plot of land, and an unlimited amount of money. Build whatever you want! You don’t have to use all of your bricks, and you can build as large or as small as you like. No rules!*

2. ADD BUILDINGS TO THE BOARD

SAY *When you finish your building, place it on the board.*

3. INTRODUCE YOUR BUILDING

Go around the room and have each person introduce his or her building.

ASK *What did you build?*

Make sure each person explains how the building is used, or what’s in it.

4. ASPHALT PLANT

Often there will be a hodge-podge of buildings—houses next to factories, big buildings next to small ones.

ASK *Would you want to live here? Why or why not?*

Now build a large and bulky asphalt plant with your own blocks and place it in the middle of the neighborhood.

ASK *What if someone built an asphalt plant here? What do you think of the neighborhood now? Would you still want to live here?*

5. **DISCUSS**

ASK *What would you worry about if you lived next to an asphalt plant?*

Some things that participants might point out: safety concerns, health problems, property values, pollution, smells, shadows, and noise. If people don't mention these, ask questions to draw them out.

ASK *What other things would you worry about if you lived in this neighborhood? Would you buy property here?*

ASK *If you were the head of the planning department for this city, how would you arrange the buildings?*

Usually people will make rules to keep factories away from houses. Sometimes they'll want to make rules to put bigger buildings in one part of the city and smaller buildings in another part. They're basically inventing zoning law themselves!

SAY *That's why zoning law exists—to keep similar things together, and to keep apart things that don't go well together. Zoning law helps protect health and safety, but it also creates a predictable environment that helps protect individual property values. You can't build a tower, but neither can your neighbor.*

Zoning law uses two major tools to shape neighborhoods—rules about use, what types of activities (like housing or industry) go where; and rules about size and shape (sometimes called “bulk”).

Activity 2

WHAT IS “USE ZONING”?

Objective The group will understand land uses, as well as how and why they are grouped and separated.

Time 15 minutes

Setup You will need the infrastructure tiles for this activity. Flip the game board to the “Zoning the City” side.

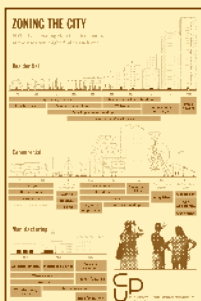

If you haven't already, distribute individual activity sheets to every person, and have them flip to the “Zoning the City” side.

SAY *We're going to build a city today. It's a little unusual because our city already has streets laid out, so we're going to build within these city blocks.*

Note: When New York City was built, there was no grid and people built out the city without these rules.

1. LAY OUT THE INFRASTRUCTURE

SAY *First we are going to build some infrastructure.*

ASK *Who wants to build the deep water port? Where would you put the deep water port? (There is a hint on the board.)*

Hand the volunteer the deep water port and ask him or her to locate it on the board. Repeat this step for each additional infrastructure tile, asking for or picking a volunteer for each. We suggest this order: deep water port, freight depot, beautiful park, airport, garbage dump, and finally subways (which fit in the intersections between white blocks).

ASK *Where should the airport go? What about the beautiful park? The freight station? (There is a hint for that one too.) And finally the subway stations?*

2. BUILD MANUFACTURING SPACE

SAY *Okay, now that we have some infrastructure, we're going to make some buildings.*

SAY *In NYC land use falls into three big categories: manufacturing, commercial, and residential. In our city the first thing we will build is manufacturing.*

ASK *What do you think counts as manufacturing?*

ASK *What kinds of things do you think are done in manufacturing zones?*

Basically manufacturing takes place where things are made and distributed. Manufacturing uses are often noisy, smelly, or dirty.

ASK *The blue building blocks represent manufacturing. Where would you put manufacturing uses in our city?*

Ask people to build manufacturing in places where they think it makes sense.

ASK *Why did you choose to build manufacturing in those places?*

If you want more detail, you can tell them that the city has different levels of manufacturing: M1—for lower impact uses like storage and woodworking shops; M2—for medium uses like big boat-building workshops; and M3—for things like waste transfer stations, water treatment plants, and asphalt factories. The higher the number, the more noise, pollution, and other impacts that manufacturing use has. This information is on the worksheets.

3. BUILD RESIDENTIAL SPACE

SAY *Now we are going to look at residential. What happens in a residential zone?*

Residential zones are where people live. Residential zones make up about 75% of NYC's land area.

SAY *There are ten major categories of residential, R1 to R10—from small to large. The higher the number, the bigger the building and the more occupants it has.*

ASK *What do you think an R1 would be?*

R1, R2—Are freestanding houses that don't touch other buildings.

SAY *Can anyone think of a neighborhood in NYC that might be zoned R1 or R2?*

Jamaica Estates in Queens,
Riverdale in the Bronx, parts of Staten Island

ASK *What do you think an R5 zone would be?*

R5, R6—Are row houses 3 to 5 stories tall, like brownstones.

ASK *Can anyone think of a neighborhood in NYC that might be zoned R5 or R6?*

Sunset Park and Bedford-Stuyvesant in Brooklyn, and Astoria in Queens

ASK *What do you think an R10 would be?*

R8 through R10—Are large apartment buildings and residential towers.

ASK *Can anyone think of a neighborhood in NYC that might be zoned R10?*

Upper East Side in Manhattan, Downtown Brooklyn

SAY *The yellow blocks are going to represent residential uses. Use them to build out the residential areas of your city. You can make them as tall or as short as you want.*

ASK *Why did you choose to build residential in those places?*

SAY *You all live in residential neighborhoods. Are there things other than housing in your neighborhood? Like what?*

Churches, schools, doctors' offices, stores, etc.

SAY *Right. Those things are all allowed in residential zones too.*

4. BUILD COMMERCIAL SPACE

SAY *Now we need to add commercial uses. What do you think counts as commercial?*

Commercial zones are places where things are bought and sold, including anything from your corner bodega to giant office towers in Midtown. In commercial zones a larger number roughly means the commercial activity serves a larger area. So a low number might be a corner store for the neighborhood (C1) and a large number might be a corporate headquarters for the region (C6). But there are some funny ones like C8, which is automotive uses (like on 4th Avenue in Brooklyn), and C7, which is amusement parks (pretty much just Coney Island).

SAY *There is also something called a “commercial overlay,” which allows commercial uses on ground floors in residential areas. You can do that here by adding red blocks to residential buildings.*

This is often called “mixed-use” in other places outside of NYC. But be careful! In NYC zoning that means something else. (We'll talk about it later.)

SAY *The red blocks represent commercial uses.*

ASK *Where would you build commercial uses in our city?*

Ask people to build some commercial buildings in our city.

ASK *Why did you choose to build commercial in those places?*

5. DISCUSS

ASK *What do you think about the city you built? Would you want to live here? Why?*

Sometimes people make changes at this point.

*Does it have everything you need in a city?
(Places to live, work, eat, shop, and relax?)*

Why did you put these things together?

Point at areas with separated uses.

ASK *Why did you keep those separate?*

Usually people keep residential and manufacturing uses apart.

SAY *You basically created zoning by putting some uses together and keeping some uses apart. You were doing the same thing that cities do when they use zoning to shape how a city develops. But most of NYC was built before zoning laws, which were only introduced in 1916.*

Zoning doesn't build or change anything, it only affects what can be built going forward. Things that already existed that don't meet the zoning rules don't get torn down; they are "grandfathered" in. The same is true when zoning laws change.

Ultimately the city develops by lots of individual land owners making decisions within the rules of what the zoning code lets them do.

Activity 3

HOW DOES A MIXED USE REZONING WORK?

Objective The group will understand the possible impacts of a mixed use rezoning.

Time 5 minutes

Setup This activity builds on the previous one, **ACTIVITY 2: WHAT IS USE ZONING?** So you should already have everything set up for that. You will need orange building blocks for this activity. Make sure every person gets an equal number of orange blocks.

1. "MIXED USE"

SAY *We've talked about how zoning doesn't change what's already been built. But changes in zoning can alter the conditions that building owners or developers respond to when they make decisions. There's a fourth category of land use we sometimes see in NYC. It's called "mixed use."*

ASK *What do you think that means?*

SAY *In other cities, the term "mixed-use" usually means areas where individual buildings have offices or storefronts on the bottom with residences above it. In NYC zoning the term "mixed use" means something different: it is when manufacturing zones are rezoned to also allow residential and commercial uses.*

In this activity you are all owners of the blue manufacturing buildings you built.

The city is rezoning this area to a mixed use zone. You can keep your manufacturing building, or you can change your building over to residential.

Before you decide, let me tell you about rent values: residential uses in this area will bring in twice as much rent per square foot as manufacturing. What do you do?

Have anyone who wants to convert to residential replace their blue blocks with orange ones. It's OK if they don't want to convert, there are always holdouts in a mixed use zone. And it is OK if they want to convert only part of their building.

2. DISCUSS

ASK *What did you do? Why?*

Ask someone that changed and someone that didn't to talk about why.

ASK *Is this a good change or a bad change for the neighborhood? Why could it be good to build more residential? Why could it be bad?*

More places for people to live could mean lower rents. But less manufacturing will mean fewer jobs, especially high-paying jobs for low-skilled workers.

SAY *Rezoning doesn't change anything on the ground and doesn't force owners to do anything. But zoning changes can dramatically shift the economics of the real estate market. How do you think the city uses that as a tool? How do you think they should use it?*

Activity 4

HOW DOES SIZE & SHAPE ZONING WORK?

Objective This series of exercises will help participants understand how the city controls the size and shape of buildings.

Time 20 minutes

Setup Flip the game board to the “Zoning the Block” side. Be sure everyone has some 2x2 and 2x4 blocks. For activities on this side of the board it doesn’t matter what color blocks are used.

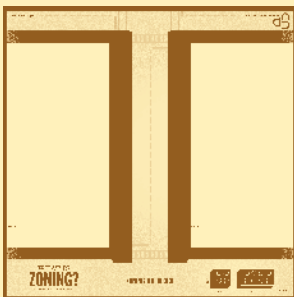

Distribute individual lot sheets to every person, and have them flip to the “Zoning the Block” side.

1. HOW BIG IS YOUR LOT?

SAY *There is a building lot on your individual lot sheet where we are going to create our own buildings for this activity. It's the same size as those lots on the board.*

What is the area (or square footage) of your lot? Does anyone remember how to calculate area?

AREA = LENGTH x WIDTH so in this case:
 $20' \times 100' = 2,000 \text{ sq. ft.}$

SAY *20' x 100' lots are pretty common in medium density neighborhoods in NYC, like brownstone neighborhoods.*

2. WHAT IS FAR?

a. Introduce FAR

SAY *The main tool the city uses to control size and shape of buildings is something called Floor Area Ratio, or F-A-R. Does anyone know what that is?*

Sometimes people do know. If not:

SAY *F-A-R is a way to think about the size of a building in relation to the size of the lot that it is built on.*

So floor area ratio is the total square footage of all the floors in a building divided by the total square footage of the building lot. The F-A-R number for different zones is written into the zoning laws.

b. Cover the lot with bricks

SAY *Now build a building that covers your entire lot and is one story tall. (The height of one brick is equal to one story.)*

What is the floor area of your building?

2,000 sq. ft.

What is the area of your lot?

2,000 sq. ft.

So if FAR is total building floor area, divided by lot area, what is the FAR?

It's one. But FAR is usually said one-point-oh—1.0

c. Re-stack your blocks

SAY *Take the same bricks on your lot (don't add or remove any), and stack them any way you like, anywhere you would like to put your building on your lot.*

What is the FAR now?

It is still 1.0.

Buildings of different shapes can have the same FAR! It's not about shape, it's about building area versus lot area.

d. Different FARs for different places

SAY *The city sets different FARs for different zones, from 0.5 to 15.0.*

Can you think of an example of a type of building that might have an FAR of 0.5?

When the FAR is 0.5 the whole building is half the size of the lot.

Detached single family houses in Riverdale

ASK *Can you think of an example of a type of building that might have an FAR of 15.0?*

The whole building would be 15x the size of the lot.

Office towers in Manhattan

e. Try it for FAR 2.0

SAY *Now build a building with an FAR of 2.0 that covers the whole lot.*

Ask participants to fill in the FAR equation on their worksheets with the numbers for a FAR 2.0 building.

When you are happy with your building, put it on a lot on the board. The building lots on the board look like the ones on your sheet, long and narrow with the narrow side facing the street. Your building has to fit between the dark lines and can't hang over onto other lots.

Have participants place the buildings close together, especially if there aren't enough people to fill all the lots on the board. This helps participants see how buildings relate to each other in a real neighborhood.

ASK *What would it be like to live in one of these buildings? Where would the windows be?*

Typically windows would only be possible on the front of the building.

ASK *What would happen if there was a fire?*

3. MAXIMUM LOT COVERAGE

ASK *To address these safety issues, the city has other rules that control the size and shape of buildings too. One of those rules is called maximum lot coverage. What do you think that means?*

Maximum lot coverage is the maximum percentage of the lot that you can build a building on.

SAY *Take your FAR 2.0 building and rearrange it so that it only covers 60% of your lot. Now it can be any shape you like and it can cover less than 60% of the lot, but not more.*

HINT Remind people to use the same number of bricks for each of these next steps to be sure they maintain an FAR of 2.0.

ASK *Why would the city have a rule like this?*

Maximum lot coverage ensures that buildings aren't too crowded together. Originally this was to help make sure tenement buildings got enough light and air, and were safe for residents to live in and get out of during fires. If everyone built to the lot line on every side there would be no windows and only one exit for emergencies!

Build:

FAR = Floor Area Ratio

FAR
2.0

Maximum lot coverage

60%

4. MINIMUM YARD REQUIREMENTS

ASK *There is another set of rules called minimum yard requirements. What do you think these rules do?*

Minimum yard requirements say where on your lot you can build your building by telling you the minimum amount of yard space you are required to have. These yards are “setbacks” that say how far back from the lot line your building has to be. They are called “yards” but in NYC they often don’t look very much like yards.

SAY *Now rearrange your same building so it has a front yard at least 10' deep and a rear yard at least 30' feet deep.*

Build:

FAR = Floor Area Ratio

FAR
2.0

Yard requirements

FRONT YARD	REAR YARD
10'	30'

Maximum lot coverage

60%

ASK *How does this neighborhood look? Would you rather live here or in the one with no lot coverage and yard requirements?*

5. HEIGHT LIMITS

ASK *But wait, there’s more! Any guesses? What other rules affect size and shape?*

SAY *The city limits how high you can build, too. In our neighborhood there is a 40' (about 4 stories—or 4 building blocks) height limit. Rearrange your building so it is a maximum of 4 stories.*

Build:

FAR = Floor Area Ratio

FAR
2.0

Yard requirements

FRONT YARD	REAR YARD
10'	30'

Maximum lot coverage

60%

Height limits

MAXIMUM	STREET WALL
40'	

SAY *But sometimes there are actually two height limits. There is the tallest point on the building—the maximum “building height”—and there is also a height limit for the front wall of the building that faces the street, which the city calls the “base height.” Rearrange your building so it still has a 40' overall height limit, but the wall facing the street has a maximum height of 30'.*

Build:

FAR = Floor Area Ratio

FAR
2.0

Yard requirements

FRONT YARD	REAR YARD
10'	30'

Maximum lot coverage

60%

Height limits

MAXIMUM	STREET WALL
40'	30'

Make sure everyone has it. Every building should be about the same size and shape with a little notch at the front.

ASK *Why does the city require a lower height limit near the street?*

More sunlight reaches the street and lower floors of buildings when the upper stories are set back.

6. DISCUSS

ASK *You started out with lots of different buildings. What happened to them?*

They look the same now.

All these rules together create an invisible boundary of the maximum space a building can occupy, which is called a “building envelope.” People usually build their buildings to fill as much of the building envelope as possible, which is called maxing out your lot. Why do they do this?

More square footage equals more rent.

ASK *What happens to the neighborhood when everyone builds to the maximum?*

All the buildings will start to look pretty similar.

Activity 5

HOW DOES A SIZE & SHAPE REZONING WORK?

Objective Participants will understand how a size & shape rezoning affects the neighborhood.

Time 5 minutes

Setup This activity builds on the previous one, **ACTIVITY 4: HOW DOES SIZE & SHAPE ZONING WORK?** So you should already have everything set up for that. Be sure there are enough building blocks remaining for people to build bigger (FAR 4.0) buildings.

1. THIS NEIGHBORHOOD IS BEING REZONED

SAY *Sometimes the city, or a developer, or a group of residents wants to change the zoning in their neighborhood. These are called “rezonings.” In recent years many changes came in the form of rezonings that the city initiated to promote growth in particular areas.*

SAY *These are called “upzonings” because of the overall increase in the intensity of uses.*

SAY *In our neighborhood, which until now was an FAR 2.0 neighborhood, the city is rezoning this area to FAR 4.0. So you have the option to keep the building you have now, or you can tear it down and rebuild it at FAR 4.0, with a higher height limit. Your building can stay as it is, or you can double your rentable square footage.*

Build:

FAR = Floor Area Ratio

FAR
4.0

Maximum lot coverage

Maximum lot coverage
60%

Yard requirements

FRONT YARD	REAR YARD
10'	30'

Height limits

MAXIMUM	STREET WALL
80'	70'

HINT If people are having trouble visualizing a FAR 4.0 building, suggest they build out a four story building that covers their entire lot, and then rearrange the blocks to meet the other requirements. Or they can just double the amount of blocks in their building from activity 4.

2. **DISCUSS**

- ASK** *Did you decide to rebuild? Why or why not?*
- SAY** *Rezoning doesn't tear anything down. Old buildings are grandfathered in. The rules only apply to new developments. An FAR increase of 50% or more will often lead to pressure to tear down old buildings and build new, bigger buildings at the maximum FAR.*
- ASK** *That's what happens in an upzoning. What do you think happens in a "downzoning"?*

In a downzoning the overall FAR is decreased. Communities often initiate downzonings as a way to protect the character of their neighborhood. This usually happens in areas where existing buildings are mostly below the allowed FAR. The rezoned FAR is meant to more closely match what is already built.

In most rezonings there is some combination of areas that are upzoned (usually near transit and on major avenues) and ones that are downzoned (on residential streets). Many rezonings are led by the city, but communities can propose them too.

Activity 6

WHAT IS INCLUSIONARY ZONING?

Objective The group will understand what options a developer has in inclusionary zoning areas.

Time 5 minutes

Setup This activity builds on **ACTIVITY 4: HOW DOES SIZE & SHAPE ZONING WORK?** So you should already have everything set up for that. There should be enough building blocks remaining for people to build bigger buildings. If you also did **ACTIVITY 5: HOW DOES A SIZE & SHAPE REZONING WORK?** and some people have FAR 4.0 buildings, just give them the option to increase the size of their building through inclusionary zoning.

1. WHAT IS INCLUSIONARY ZONING?

ASK *Zoning is mostly used to control how buildings look and how they are used. But sometimes the city uses zoning to meet other goals. They do this by letting developers build more if they agree to provide other benefits. Can you think of any examples?*

Community facilities, subway stations, public parks, plazas, and affordable housing.

ASK *One way the city uses these incentives is encouraging developers to build affordable housing through something called “inclusionary zoning.” Does anyone know how inclusionary zoning works?*

Sometimes someone does know. Inclusionary zoning is when the city allows a developer to build a bigger building if part of the building is set aside for affordable housing. This currently only applies in particular districts the city has identified as target areas (like Greenpoint/Williamsburg or 4th Avenue in Brooklyn).

2. BONUS FAR BUILDING

SAY *In inclusionary zoning areas developers have the option to get an FAR bonus and build a bigger building if they make some of their building affordable housing. Usually they can build a 33% bigger building if 20% of the units are made affordable.*

In our neighborhood on the game board, the FAR is 4.0. You now have the option to keep your FAR 4.0 building or build a new building with 20% affordable housing and

a 33% larger FAR of 5.4. (That is equal to seven 2x2 blocks.)

It may help people to visualize this if you ask them to build the 20% affordable housing with four 2x2 orange blocks, and the rest of the building with a different color.

Build:

FAR = Floor Area Ratio

FAR
5.4

Maximum lot coverage

60%

Yard requirements

FRONT YARD	REAR YARD
10'	30'

Height limits

MAXIMUM	STREET WALL
100'	90'

Here's how the math works:

$$\text{FAR } 4.0 + (.33 \times 4.0)$$

$$\text{FAR } 4.0 + 1.32 =$$

$$\text{New FAR} = 5.32 \text{ (we'll call it 5.4)}$$

ASK

Do you take the bonus? Why or why not?

3. DISCUSS

ASK

Why does the city use inclusionary zoning?

ASK

What do you think of this neighborhood?

ASK

What could be good about inclusionary zoning? What could be bad?

The city wants more affordable housing but doesn't have the money to build it all. So instead they create incentives for private developers to build some units of affordable housing.

More affordable housing does get built, but not enough to meet the entire need. Also, developers often make their affordable housing units "affordable" to middle income people, so the question always has to be asked: affordable to whom?

ASK

Do you think everyone would take the bonus? Why or why not?

SAY

It can really vary. In some places like Williamsburg, almost everyone took the bonus when it was offered. In others, like 4th Avenue in Park Slope, almost no one took it. It largely depends on how hot the real estate market in that area is. If developers know they can rent or sell all the units easily, they are more likely to take the bonus.

That also mean that this doesn't work when no one is building!

What's my zone?

This is what a zoning map looks like. Every block in the city has a zone designation.

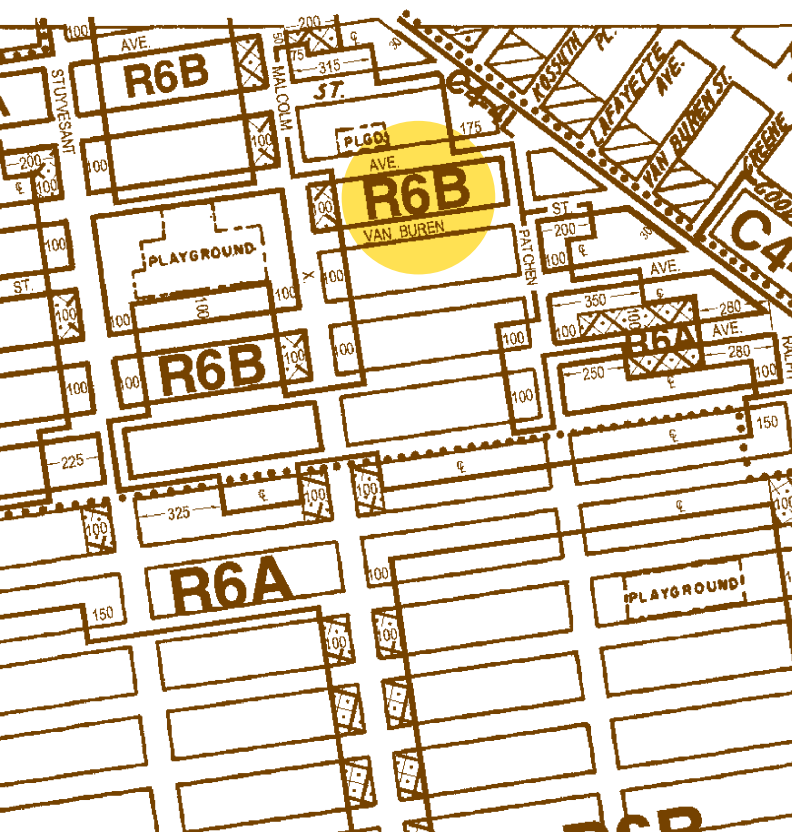

Every part of NYC is in a zone. Every zone has a classification that tells you what kind of things can be built in that zone.

R6B

The first character is the land use, or what the buildings in this zone can be used for.

In NYC, it can be:

R = residential

C = commercial

M = manufacturing

MX = "mixed use"

Find out more on page 22.

The second character refers to the scale of development.

For residential, it can be R1 (single family) to R10 (skyscraper).

For commercial, it can be C1 to C8. Smaller numbers usually mean more local-serving businesses, C6 means large corporate headquarters, and C7 means amusement parks!

For manufacturing, it can be M1 (least impact on surrounding areas), M2, or M3 (most impact).

Find out more on page 42.

The third character means this zone has additional requirements to make it "contextual," which means to make sure that new buildings have similar size, shape, or look to existing buildings in that zone.

This can be A, B, D, or X.

Find out more on page 70.



This book: **WHAT IS ZONING?** is part of the **Envisioning Development Toolkits**, a series of teaching tools that foster conversations and group learning about land use and urban development.

The **Envisioning Development Toolkits** allow everyday New Yorkers to use the language that professionals use to describe land use processes and outcomes. They provide visual and tactile tools to facilitate discussions, describe and clarify problems, and propose and communicate solutions.

WHAT IS ZONING? breaks down density, bulk, land use, and how proposed rezonings could affect your neighborhood.

Find out more about this and other tools at: welcometoCUP.org



THE CENTER FOR URBAN PEDAGOGY